



CARLO GAVAZZI



IO-Link photoelectric laser sensor

LD30CPBRxxBPxxIO

Instruction manual

Table of contents

1. Introduction	4
1.1. Description	4
1.2. Validity of documentation	4
1.3. Who should use this documentation	4
1.4. Use of the product	4
1.5. Safety precautions	4
1.7. Acronyms	5
2. Product	6
2.1. Main features	6
2.2. Identification number	6
2.3. Operating modes	7
2.3.1. SIO mode	7
2.3.2. IO-Link mode	7
2.3.3. Process data	8
2.4. Output Parameters	9
2.4.1. Sensor front	9
2.4.1.1. SSC (Switching Signal Channel)	9
2.4.1.2. Switchpoint mode	10
2.4.1.3. Hysteresis Settings	11
2.4.1.4. Background Suppression, Foreground Suppression and Dual Detection mode	12
2.4.1.5. Dust alarm 1 and Dust alarm 2	12
2.4.1.6. Temperature alarm (TA)	12
2.4.1.7. External input	13
2.4.2. Input selector	13
2.4.3. Logic function block	13
2.4.4. Timer (Can be set individually for Out1 and Out2)	15
2.4.4.1. Timer mode	15
2.4.4.1.1. Disabled	15
2.4.4.1.2. Turn On delay (T-on)	15
2.4.4.1.3. Turn Off delay (T-off)	15
2.4.4.1.4. Turn ON and Turn Off delay (T-on and T-off)	16
2.4.4.1.5. One shot leading edge	16
2.4.4.1.6. One shot trailing edge	16
2.4.4.2. Timer scale	17
2.4.4.3. Timer Value	17
2.4.5. Output Inverter	17
2.4.6. Output stage mode	17
2.4.7. Application functions	18
2.4.7.1. Dual Detection	18
2.4.7.2. Speed and Length	19
2.4.7.2.1. Conditions	19
2.4.7.2.2. Speed and Length – Setup procedure	19
2.4.7.3. Pattern Recognition	20
2.4.7.3.1. Conditions	20
2.4.7.3.2. Pattern recognition – Setup procedure	20
2.4.7.4. Divider function	22
2.4.7.4.1. Conditions	22
2.4.7.4.2. Divider function – Setup procedure	22
2.4.7.5. Object and Gap Monitoring	23
2.4.7.5.1. Conditions	23
2.4.7.5.2. Object and Gap Monitoring – Setup procedure	23
2.5. Sensor Specific adjustable parameters	25
2.5.1. Selection of local or remote adjustment	25
2.5.2. Teach-in range	25
2.5.3. Process data configuration	25
2.5.4. Sensor Measurement Selection	25
2.5.4.1. Fine detection	25
2.5.4.2. Robust detection	25
2.5.4.3. Fast detection	26
2.5.5. Temperature alarm threshold	26
2.5.6. Safe limits	26
2.5.6.1. Stable ON	26
2.5.6.2. Stable OFF	26

2.5.7. Event configuration	26
2.5.8. Excess Gain	26
2.5.9. Quality of run QoR	27
2.5.10. Quality of Teach QoT	27
2.5.11. Filter Scaler	28
2.5.12. Mutual interference	28
2.5.13. LED indication	28
2.5.14. Hysteresis mode	28
2.5.15. Auto hysteresis value	28
2.5.16. Cutoff distance	28
2.6. Teach procedure by use of SCTL55 or an IO-Link master	29
2.6.1. Dual Detection mode	29
2.6.2. FGS mode	29
2.6.3. BGS mode	30
2.6.4. Teach from IO-Link Master or Smart configurator (SCTL55)	32
2.6.4.1. Single point mode procedure	33
2.6.4.2. Two point mode procedure	34
2.6.4.3. Windows mode procedure	35
2.6.4.4. Foreground suppression mode	36
2.6.4.5. Dual Detection mode	36
2.7. Diagnostic parameters	37
2.7.1. Operating hours	37
2.7.2. Number of power cycles [cycles]	37
2.7.3. Maximum temperature – all time high [°C]	37
2.7.4. Minimum temperature – all time low [°C]	37
2.7.5. Maximum temperature since last power-up [°C]	37
2.7.6. Minimum temperature since last power-up [°C]	37
2.7.7. Current temperature [°C]	37
2.7.8. Detection counter [cycles]	37
2.7.9. Minutes above maximum temperature [min]	37
2.7.10. Minutes below minimum temperature [min]	37
2.7.11. Download counter	37
3. Wiring diagrams	38
4. Commissioning	38
2.7.12. Dual Detection result	38
5. Operation	39
5.1. User interface of LD30CPBRxxBPxxIO	39
6. IODD file and factory setting	40
6.1. IODD file of an IO-Link device	40
6.2. Factory settings	40
7. Appendix	40
7.1. Acronyms	40
7.2. IO-Link Device Parameters for LD30CPBR IO-Link	41
7.2.1. Device Identification	41
7.2.2. Observation	41
7.2.3. SSC parameters	42
7.2.4. Output Parameters	43
7.2.5. Sensor specific adjustable parameters	44
7.2.6. Application Function	45
7.2.6.1. Dual Detection	45
7.2.6.2. Speed and Length	45
7.2.6.3. Pattern Recognition	46
7.2.6.4. Divider	46
7.2.6.5. Object and Gap Monitoring	47
7.2.7. Diagnostic parameters	48
Dimensions	49
Installation Hints	49
Sensing Condition	50
Detection diagram	51

1. Introduction

This manual is a reference guide for Carlo Gavazzi IO-Link photoelectric laser sensors LD30CPBRxxBPxxIO. It describes how to install, setup and use the product for its intended use.

1.1. Description

Carlo Gavazzi photoelectric laser sensors are devices designed and manufactured in accordance with IEC international standards and are subject to the Low Voltage (2014/35/EU) and Electromagnetic Compatibility (2014/30/EU) EC directives.

All rights to this document are reserved by Carlo Gavazzi Industri, copies may be made for internal use only. Please do not hesitate to make any suggestions for improving this document.

1.2. Validity of documentation

This manual is valid only for LD30CPBRxxBPxxIO photoelectric laser sensors with IO-Link and until new documentation is published.

1.3. Who should use this documentation

This instruction manual describes the function, operation and installation of the product for its intended use. This manual contains important information regarding installation and must be read and completely understood by specialized personnel dealing with these photoelectric sensors. We highly recommend that you read the manual carefully before installing the sensor. Save the manual for future use. The Installation manual is intended for qualified technical personnel.

1.4. Use of the product

These photoelectric laser sensors are designed with Background/Foreground Suppression, meaning it is detecting the object via triangulation, however it can also indicate the actual distance in mm via the process data in IO-Link mode. The receiver is a detector array that performs precise detection independent of the colour of the object and allows elimination of a background.

The LD30CPBRxxBPxxIO sensors can operate with or without IO-Link communication. By means of an IO-Link master it is possible to operate and configure these devices.

1.5. Safety precautions

This sensor must not be used in applications where personal safety depends on the function of the sensor (The sensor is not designed according to the EU Machinery Directive).

Installation and use must be carried out by trained technical personnel with basic electrical installation knowledge. The installer is responsible for correct installation according to local safety regulations and must ensure that a defective sensor will not result in any hazard to people or equipment. If the sensor is defective, it must be replaced and secured against unauthorised use.



Class 1 laser according to IEC 60825-1:2014
Complies with IEC/EN 60825-1:2014 and 21 CFR 1040.10 1040.11
except for deviations pursuant to Laser Notice No. 56, dated January
19, 2018

1.6. Other documents

It is possible to find the datasheet, the IODD file and the IO-Link parameter manual on the Internet at <http://gavazziautomation.com>

1.7. Acronyms

I/O	Input/Output
PD	Process Data
PLC	Programmable Logic Controller
SIO	Standard Input Output
SP	Setpoints
IODD	I/O Device Description
IEC	International Electrotechnical Commission
NO	Normally Open contact
NC	Normally Closed contact
NPN	Pull load to ground
PNP	Pull load to V+
Push-Pull	Pull load to ground or V+
QoR	Quality of Run
QoT	Quality of Teach
UART	Universal Asynchronous Receiver-Transmitter
SO	Switching Output
SSC	Switching Signal Channel
DA	Dust alarm
AFO	Application function output
TA	Temperatur alarm
BGS	Background Suppression
FGS	Foreground Suppression
DD	Dual Detection

2. Product

2.1. Main features

IO-Link Carlo Gavazzi 4-wire DC photoelectric Background/Foreground Suppression sensors with red laser light, built to the highest quality standards, are available in Plastic (ABS) IP67 approved housing material. They can operate in standard I/O mode (SIO), which is the default operation mode. When connected to an SCTL55 or an IO-Link master, they automatically switch to IO-Link mode and can be operated and easily configured remotely.

Thanks to their IO-Link interface, these sensors are much more intelligent and feature many additional configuration options, such as the settable sensing distance and hysteresis, also timer functions of the output. Advanced functionalities such as the Logic function block and the possibility to convert one output into an external input makes the sensor highly flexible.

Application functions such as; Pattern recognition, Speed and Length monitoring, Divider function and Object and Gap detection are de-central functions dedicated to solve specific sensing tasks.

2.2. Identification number

Code	Option	Description
L	-	Photoelectric Laser Sensor
D	-	Rectangular housing
30	-	Housing size
C	-	Plastic housing - ABS
P	-	Teach-button
B	-	Background/Foreground Suppression
R	-	Red light
□	10	100 mm sensing distance
	30	300 mm sensing distance
	60	600 mm sensing distance
B	-	Selectable functions: NPN, PNP, Push-Pull, External Input (only pin 2), External teach input (only pin 2)
P	-	Selectable: NO or NC
□	A2	2 metre PVC cable
	M5	M8, 4-pole connector
IO	-	IO-Link version

Additional characters can be used for customized versions.

2.3. Operating modes

IO-Link photoelectric sensors are provided with two switching outputs (SO) and can operate in two different modes: SIO mode (standard I/O mode) or IO-Link mode (pin 4).

2.3.1. SIO mode

When the sensor operates in SIO mode (default), a SCTL55 or an O-Link master is not required. The device works as a standard photoelectric sensor, and it can be operated via a fieldbus device or a controller (e.g. a PLC) when connected to its PNP, NPN or push-pull digital inputs (standard I/O port). One of the greatest benefits of these photoelectric sensors is the possibility to configure them via a SCTL55 or an O-Link master and then, once disconnected from the master, they will keep the last parameter and configuration settings. In this way it is possible, for example, to configure the outputs of the sensor individually as a PNP, NPN or push-pull, or to add timer functions such as T-on and T-off delays or logic functions and thereby satisfy several application requirements with the same sensor.

2.3.2. IO-Link mode

IO-Link is a standardized IO technology that is recognized worldwide as an international standard (IEC 61131-9). It is today considered to be the “USB interface” for sensors and actuators in the industrial automation environment. When the sensor is connected to one IO-Link port, the SCTL55 or IO-Link master sends a wakeup request (wake up pulse) to the sensor, which automatically switches to IO-Link mode: point-to-point bidirectional communication then starts automatically between the master and the sensor.

IO-Link communication requires only standard 3-wire unshielded cable with a maximum length of 20 m.

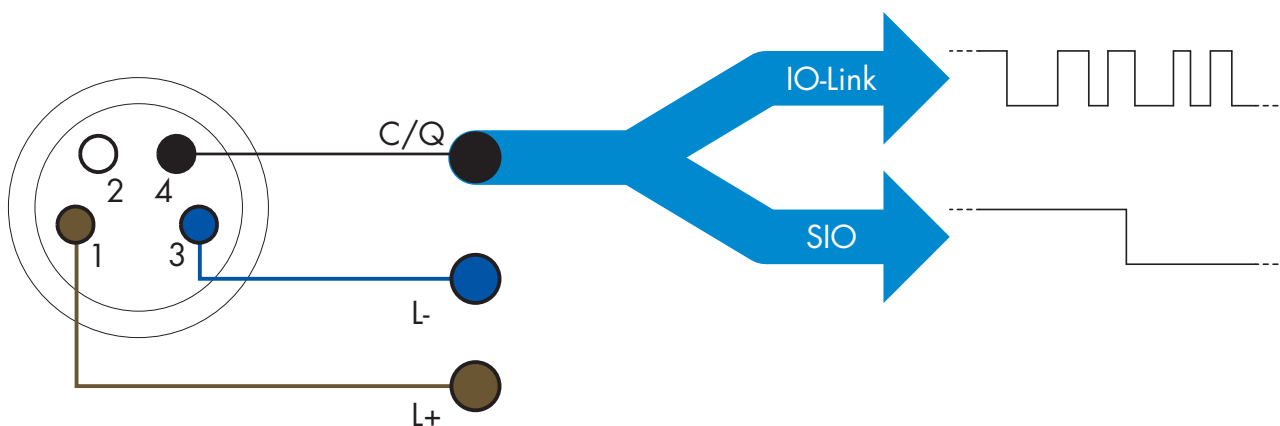

IO-Link communication takes place with a 24 V pulse modulation, standard UART protocol via the switching and communication cable (combined switching status and data channel C/Q) PIN 4 or black wire.

For instance, an M8 4-pin male connector has:

- Positive power supply: pin 1, brown
- Negative power supply: pin 3, blue
- Digital output 1: pin 4, black
- Digital output 2: pin 2, white

The transmission rate of LD30CPBRxxBPxxIO sensors is 38.4 kBaud (COM2).

Once connected to the IO-Link port, the master has remote access to all the parameters of the sensor and to advanced functionalities, allowing the settings and configuration to be changed during operation, and enabling diagnostic functions, such as temperature warnings, temperature alarms and process data.

Thanks to IO-Link it is possible to see the manufacturer information and part number (Service Data) of the device connected, starting from V1.1. Thanks to the data storage feature it is possible to replace the device and automatically have all the information stored in the old device transferred into the replacement unit.

Access to internal parameters allows the user to see how the sensor is performing, for example by reading the internal temperature.

Event Data allows the user to get diagnostic information such as an error, an alarm, a warning or a communication problem.

There are two different communication types between the sensor and the master and they are independent of each other:

- Cyclical for process data and value status – this data is exchanged cyclically.
- Acyclical for parameter configuration, identification data, diagnostic information and events (e.g. error messages or warnings) – this data can be exchanged on request.

2.3.3. Process data

By default the process data shows the following parameters as active: 16 bit Analogue value, Switching Output1 (SO1) and Switching Output 2 (SO2).

The following parameters are set as Inactive: SSC1, SSC2, TA, SC, DA1, DA2, AFO1.

However by changing the Process Data Configuration parameter, the user can decide to also enable the status of the inactive parameters. This way several states can be observed in the sensor at the same time.

Process data can be configured. See 2.5.3. Process data configuration.

Byte 0	31	30	29	28	27	26	25	24
	MSB							
Byte 1	23	22	21	20	19	18	17	16
								LSB
Byte 2	15	14	13	12	11	10	9	8
			SC	TA	DA2	DA1	SSC2	SSC1
Byte 3	7	6	5	4	3	2	1	0
	AFO1						SO2	SO1

4 Bytes

Analogue value 16 ... 31 (16 BIT)

2.4. Output Parameters

Seven sensing functions and 5 application functions can be selected. These values can be independently adjusted and used as source for the Switching Output 1 or 2; in addition to those, an external input can be selected for SO2. After selecting one of these sources, it is possible to configure the output of the sensor with a SCTL55 or an IO-Link master, following the seven steps shown in the Switching Output setup below.

Once the sensor has been disconnected from the master, it will switch to the SIO mode and keep the last configuration setting.

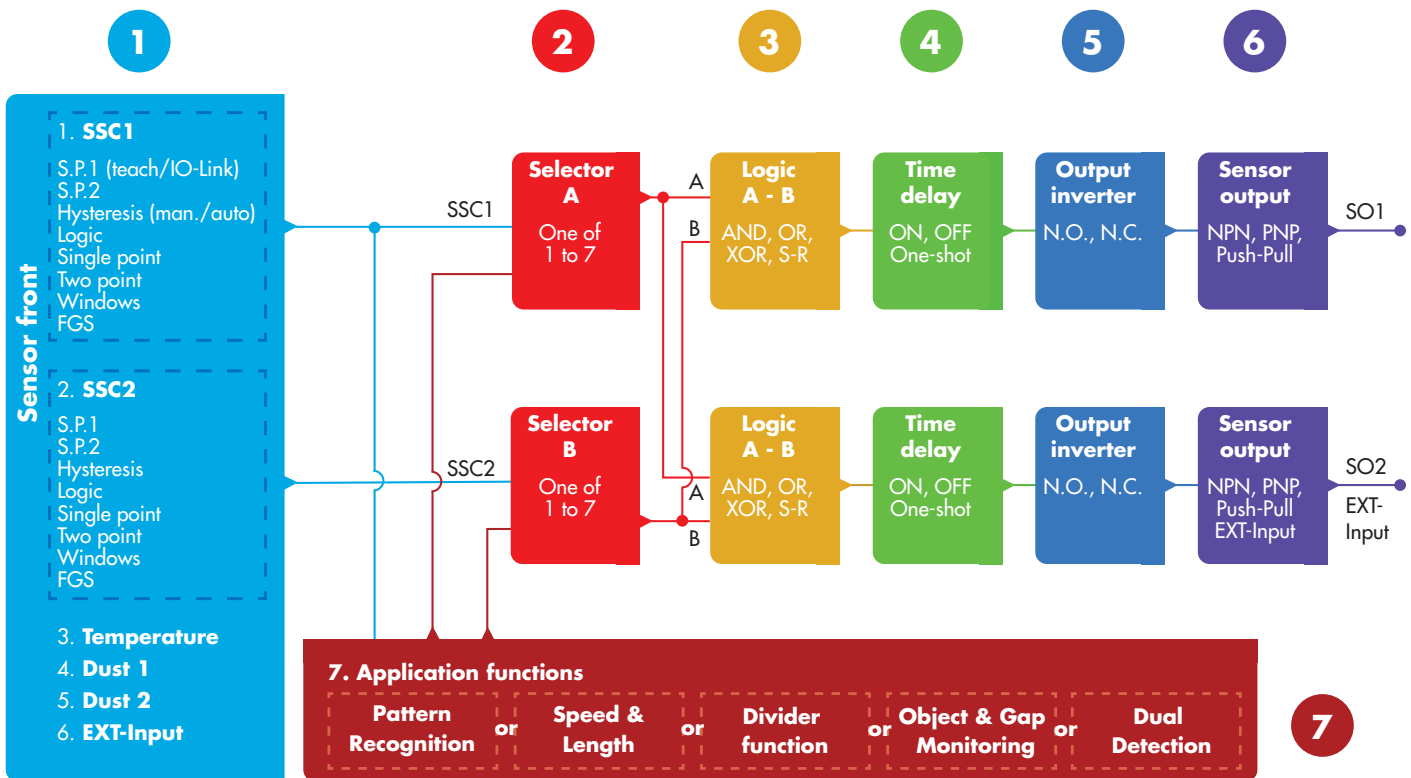

1

2.4.1. Sensor front

The Background/Foreground Suppression sensor emits red laser light towards a target and measure the position of the light reflected from the target. If the measured position value is equal to or less than a predefined position for the target, the sensor changes the output state. The measured sensing distance is almost independent of the target colour.

2.4.1.1. SSC (Switching Signal Channel)

For presence (or absence) detection of an object in front of the face of the sensor, the following settings are available: SSC1 or SSC2. Setpoints can be set from

- LD30CPBR10: 20 ... 125 mm*
- LD30CPBR30: 20 ... 325 mm*
- LD30CPBR60: 20 ... 625 mm*

* It is not recommended to use settings higher than maximum 100, 300 and 600 mm depending on the sensor type however under optimal conditions (ambient light environment and EMC noise etc.) the distance can be set at higher value.

2.4.1.2. Switchpoint mode:

Each SSC channel can be set operate in 4 modes or be disabled. The Switchpoint mode setting can be used to create more advanced output behaviour. The following switchpoint modes can be selected for the switching behaviour of SSC1 and SSC2

Disabled

SSC1 or SSC2 can be disabled individually.

Single point mode

The switching information changes, when the distance passes the threshold defined in setpoint SP1, with rising or falling distances, taking into consideration the hysteresis settings stored in the sensor.

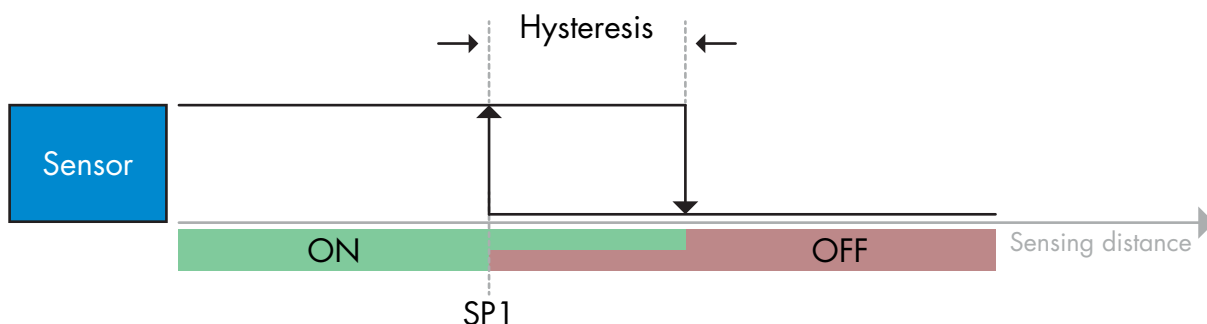

Example of presence detection - with non-inverted logic

Two point mode

The switching information changes when the distance measured passes the threshold defined in setpoint SP1. This change occurs only with decreasing distance measured. The switching information also changes when the distance measured passes the threshold defined in setpoint SP2. This change occurs only with increasing distance measured. Hysteresis settings stored in the sensor are not applied in this case. The hysteresis results from the difference between SP1 and SP2.

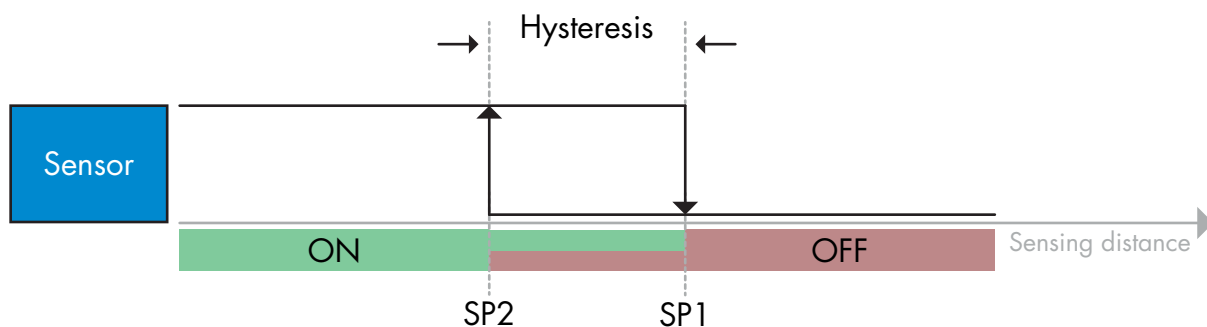

Example of presence detection - with non-inverted logic

Window mode

The switching information changes, when the distance measured passes the thresholds defined in setpoint SP1 and setpoint SP2, with increasing or decreasing distance measured, taking into consideration the hysteresis settings stored in the sensor.

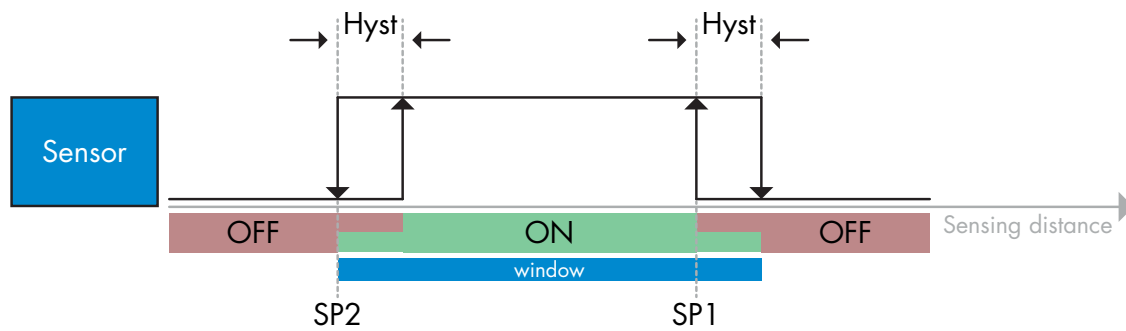

Example of presence detection - with non-inverted logic

Foreground suppression Mode

In foreground suppression mode, the sensor is set to detect a background in a predefined distance. If the background is no longer detected in this predefined distance, e.g. because the reflected light from the background is blocked by an object, the sensor changes the output state.

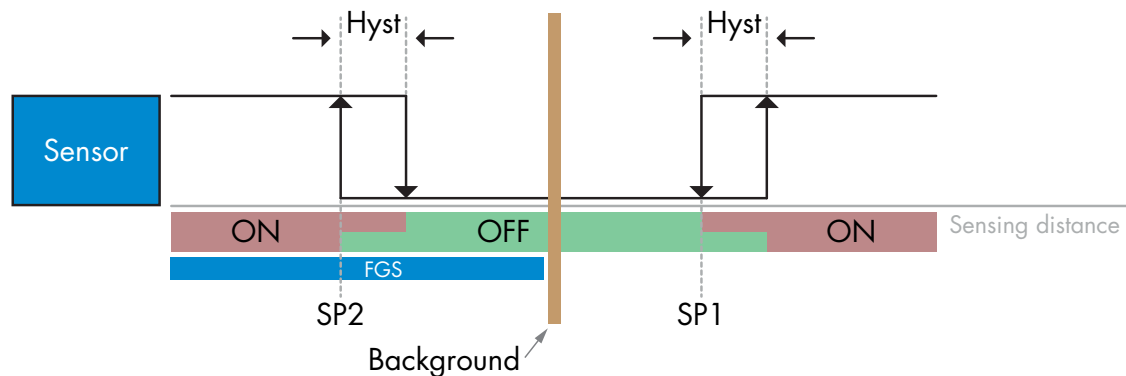

Example of presence detection - with non-inverted logic

2.4.1.3. Hysteresis Settings

The hysteresis can be set manual, standard automatic or fine automatic for SSC1 and manual only for SSC2. The hysteresis is set in mm for SP1 and SP2.

Note: When teach-button is selected, the default hysteresis is Fine automatic.

Manual hysteresis:

When manual hysteresis is selected the hysteresis can be changed between

- LD30CPBR10: 1.0 ... 125.0 mm
- LD30CPBR30: 1.0 ... 325.0 mm
- LD30CPBR60: 1.0 ... 625.0 mm

For application that require a hysteresis other than the automatic, the hysteresis can be configured manually. This feature makes the sensor more versatile.

Note: Special attention to the application must be considered when choosing a hysteresis lower than the automatic hysteresis.

Standard automatic hysteresis:

Standard automatic hysteresis will guarantee stable operation for most applications.

Hysteresis is calculated with reference to SP1/SP2 and the actual values can be read via parameter "SSC1 Auto hysteresis", typically

- LD30CPBR10: 7 mm
- LD30CPBR30: 20 mm
- LD30CPBR60: 40 mm

Fine automatic hysteresis:

Fine automatic hysteresis set the hysteresis at minimum optimized for detection close to a background. Hysteresis is calculated with reference to SP1/SP2 and the actual values can be read via parameter "SSC1 Auto hysteresis", typically

- LD30CPBR10: 7 mm
- LD30CPBR30: 20 mm
- LD30CPBR60: 40 mm

2.4.1.4. Background Suppression, Foreground Suppression and Dual Detection mode**Background Suppression:**

A Background suppression sensor (BGS) prevents an object beyond the set distance from being detected. Objects within the set distance are detected at their position and with the signal strength of the received light.

The detection capabilities of the sensor are almost independent of the colour of the object as it uses the position of the reflected light for detection. Dead black objects or shiny objects that reflects the laser light away from the sensor will not be detected.

A BGS sensor does not need a physical background to operate.

Foreground Suppression:

A Foreground Suppression sensor (FGS) needs a background as reference target. If the sensor does not recognize the background, an object must be present, that either;

- Sends the laser light back to the sensor, however the detected distance is shorter than the set distance for the background.
- Absorbs the laser light so no light is reflected to the sensor e.g. dead black objects.
- Deflects the laser light so no light is received by the sensor e.g. highly reflective objects.

In case reflected light from highly reflective objects is detected briefly due to object movements, an ON timer can be added to keep the output steady.

A FGS sensor needs a physical background to operate.

Dual Detection:

A Dual Detection function (DD) is based upon a FGS function in combination with a Diffuse Reflective sensor. Just as the BGS sensor it requires a background as reference target where both the distance to the background as well as the reflected light intensity defines the expected conditions for the background. If the sensor does not recognize the background, an object must be present, that either:

- Changes the position of the light received from the background, dead black or shiny objects
- Changes the intensity of the light reflected from the background, e.g. transparent PET bottles
- Changes a combination of position and intensity.

2.4.1.5. Dust alarm 1 and Dust alarm 2

Minimum Excess Gain is used for dust alarm levels and is set as a common value for both SSC1 and SSC2. The dust alarm will be active after a preset time, if the measured Excess Gain value is below the Minimum Excess gain.

See 2.5.10 Excess Gain.

2.4.1.6. Temperature alarm (TA)

The sensor constantly monitors the internal temperature. Using the temperature alarm setting it is possible to get an alarm from the sensor if temperature thresholds are exceeded. See §2.5.5.

Two independent temperature alarm settings can be set. One for the maximum temperature alarm and one for the minimum temperature alarm.

It is possible to read the temperature of the sensor via the acyclic IO-Link parameter data.

NOTE!

The temperature measured by the sensor will always be higher than the ambient temperature, due to internal heating.

The difference between ambient temperature and internal temperature is influenced by how the sensor is installed in the application.

2.4.1.7. External input

The output 2 (SO2) can be configured as an external input allowing external signals to be fed into the sensor, e.g. from a second sensor or from a PLC or directly from machine output.

2

2.4.2. Input selector

This function block allows the user to select any of the signals from the "sensor front" to the Channel A or B. Channels A and B: can select from SSC1, SSC2, Dust alarm 1, Dust alarm 2, Water drop alarm 1, Water drop alarm 2, Temperature alarm and External input.

3

2.4.3. Logic function block

In the logic function block a logic function can be added directly to the selected signals from the input selector without using a PLC – making decentralised decisions possible.

The logic functions available are: AND, OR, XOR, SR-FF.

AND function

Symbol	Truth table		
 <p>2-input AND Gate</p>	A	B	Q
	0	0	0
	0	1	0
	1	0	0
	1	1	1
Boolean Expression Q = A.B	Read as A AND B gives Q		

OR function

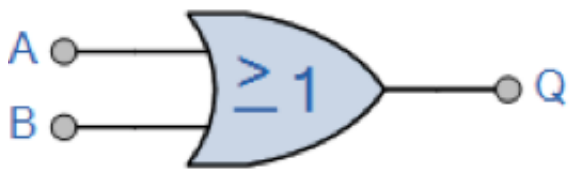
Symbol	Truth table		
 <p>2-input OR Gate</p>	A	B	Q
	0	0	0
	0	1	1
	1	0	1
	1	1	1
Boolean Expression Q = A + B	Read as A OR B gives Q		

XOR function

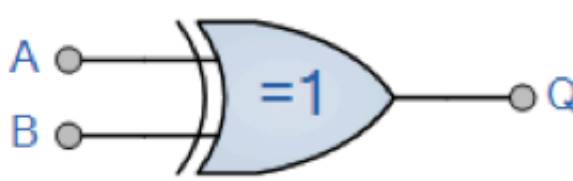
Symbol	Truth table		
 <p>2-input XOR Gate</p>	A	B	Q
	0	0	0
	0	1	1
	1	0	1
	1	1	0
Boolean Expression Q = A ⊕ B	A OR B but NOT BOTH gives Q		

"Gated SR-FF" function

The function is designed to: e.g. start or stop signal for a buffer conveyor dependent on the fill status of the adjacent feeder or receiver conveyor using only two interconnected sensors.

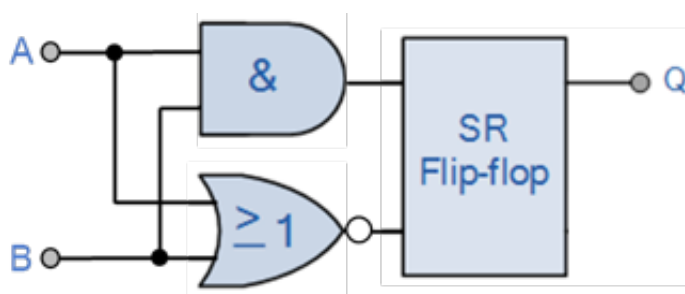
Symbol	Truth table		
	A	B	Q
	0	0	0
	0	1	X
	1	0	X
	1	1	1

X – no changes to the output.

2.4.4. Timer (Can be set individually for Out1 and Out2)

The Timer allows the user to introduce different timer functions by editing the 3 timer parameters:

- Timer mode
- Timer scale
- Timer value

2.4.4.1. Timer mode

This selects which type of timer function is introduced on the Switching Output. Any one of the following is possible:

2.4.4.1.1. Disabled

This option disables the timer function no matter how the timer scale and timer delay is set up.

2.4.4.1.2. Turn On delay (T-on)

The activation of the switching output is generated after the actual sensor actuation as shown in the figure below.

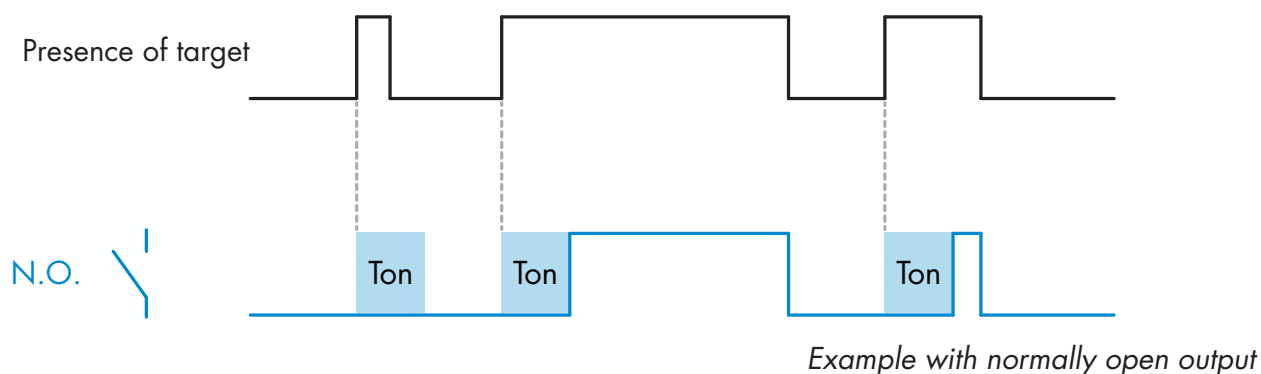

2.4.4.1.3. Turn Off delay (T-off)

The deactivation of the switching output is delayed until after to the time of removal of the target in the front of the sensor, as like shown in the figure below.

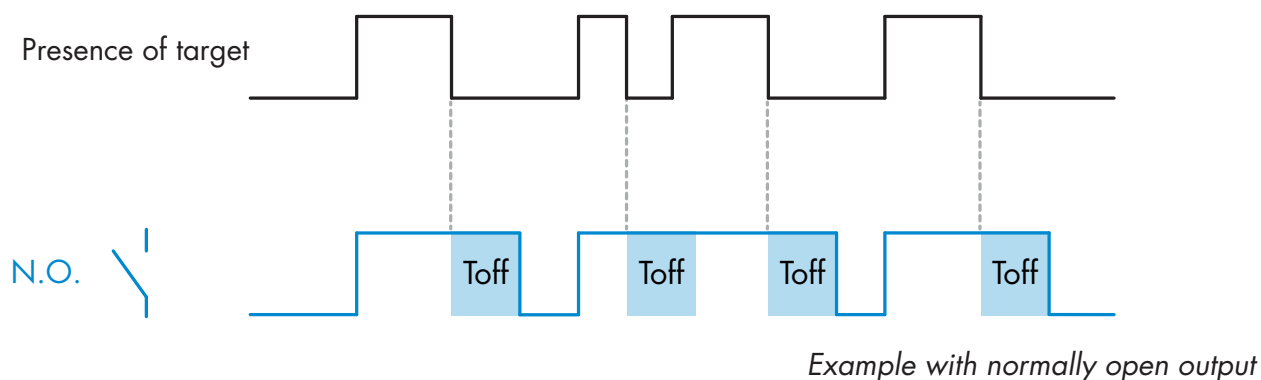

2.4.4.1.4. Turn ON and Turn Off delay (T-on and T-off)

When selected, both the T_{on} and the T_{off} delays are applied to the generation of the switching output.

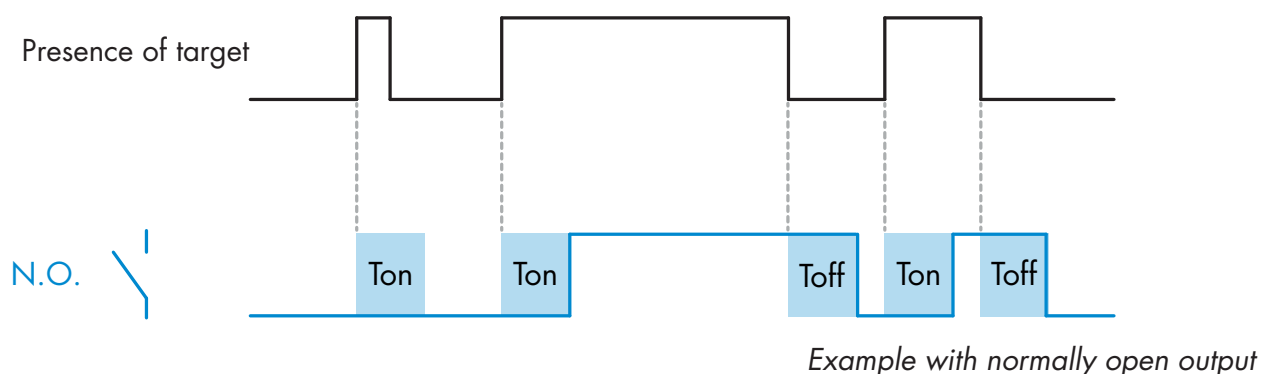

2.4.4.1.5. One shot leading edge

Each time a target is detected in front of the sensor the switching output generates a pulse of constant length on the leading edge of the detection. This function is not retriggerable. See figure below.

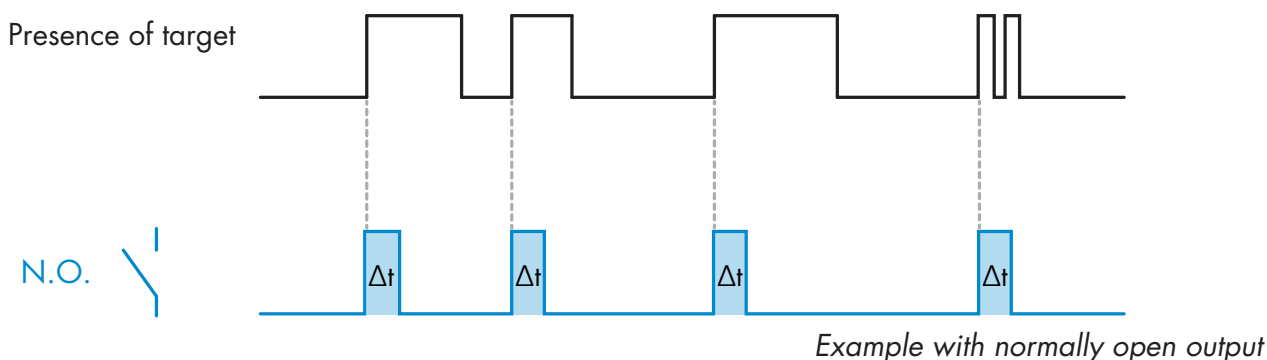

2.4.4.1.6. One shot trailing edge

Similar in function to the one shot leading edge mode, but in this mode the switching output is changed on the trailing edge of the activation as shown in the figure below. This function is not retriggerable.

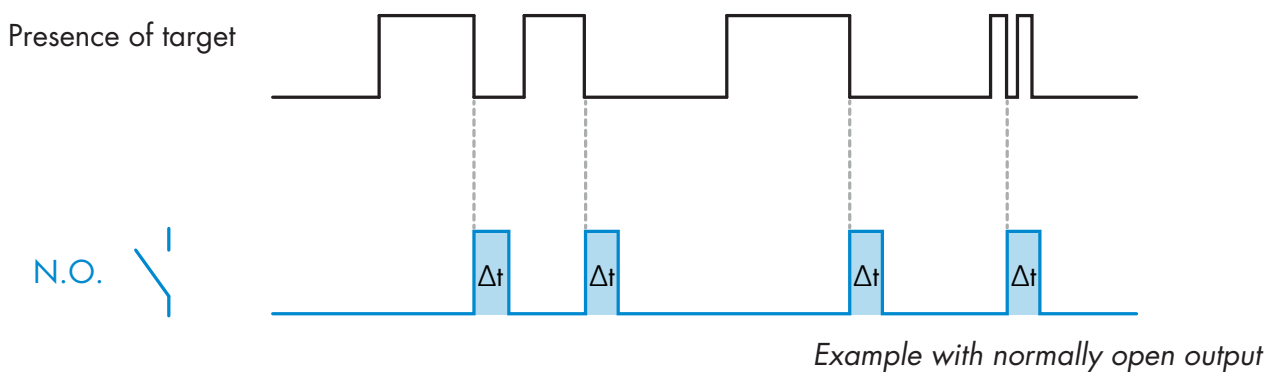

2.4.4.2. Timer scale

The parameter defines if the delay specified in the Timer delay should be in milliseconds, seconds or minutes

2.4.4.3. Timer Value

The parameter defines the actual duration of the delay. The delay can be set to any integer value between 1 and 32 767.

5

2.4.5. Output Inverter

This function allows the user to invert the operation of the switching output between Normally Open and Normally Closed.

RECOMMENDED FUNCTION

The recommended function is found in the parameters under 64 (0x40) sub index 8 (0x08) for SO1 and 65 (0x41) sub index 8 (0x08) for SO2. It has no negative influence on the Logic functions or the timer functions of the sensor as it is added after those functions.

CAUTION!

The Switching logic function found under 61 (0x3D) sub index 1 (0x01) for SSC1 and 63 (0x3F) sub index 1 (0x01) for SSC2 are not recommended for use as they will have a negative influence on the logic or timer functions. Using this function will turn an ON delay into an Off delay if it is added for the SSC1 and SSC2. It is only for the SO1 and SO2.

6

2.4.6. Output stage mode

In this function block the user can select if the switching outputs should operate as:

- SO1: Disabled, NPN, PNP or Push-Pull configuration.
- SO2: Disabled, NPN, PNP, Push-Pull, External input (Active high/Pull-down), External input (Active low/pull up) or External Teach (Active high) input.

2.4.7. Application functions

5 unique application functions can be selected via IO-Link only.

- Dual Detection.
- Speed and Length.
- Pattern Recognition.
- Divider.
- Object and Gap Monitoring.

All application functions are disabled as factory setting.

2.4.7.1. Dual Detection

A dual detection sensor works as a foreground suppression sensor combined with a diffuse reflective sensor. This sensing principle evaluates both the position change as well as the light intensity of the received light.

When teaching the background, a detection window for both the position and the light intensity is set to $\pm 75\%$ of the position and $\pm 75\%$ of the received light intensity.

- If the received light falls within the borders of the green box (see below) then it is considered to be the reference background signal.
- If the received signal is outside the borders of the green box it is considered to be an object.

Background

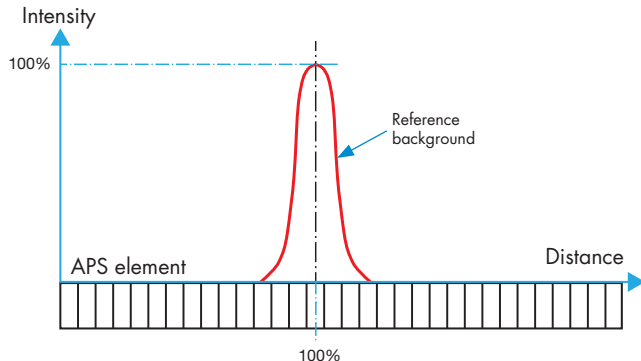

Dual Detection

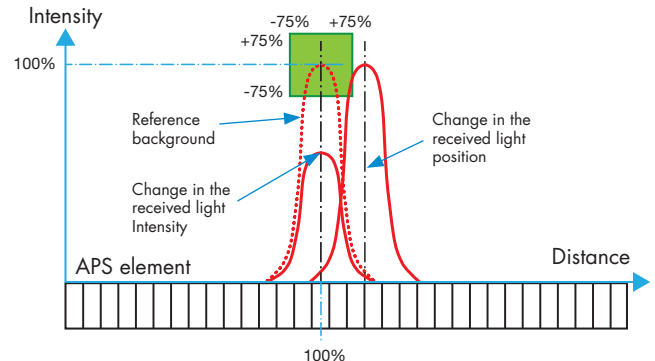

2.4.7.2. Speed and Length

This function is designed to monitor the length of an object as well as the speed of a conveyor belt by means of only two interconnected sensors. The actual value of the length in [mm] and the speed in [mm/s] are directly available on the IO-Link master.

Either the length or the speed can be set as process data.

2.4.7.2.1. Conditions

Two sensors are needed for this function: a Trigger sensor and a Main sensor.

2.4.7.2.2. Speed and Length – Setup procedure

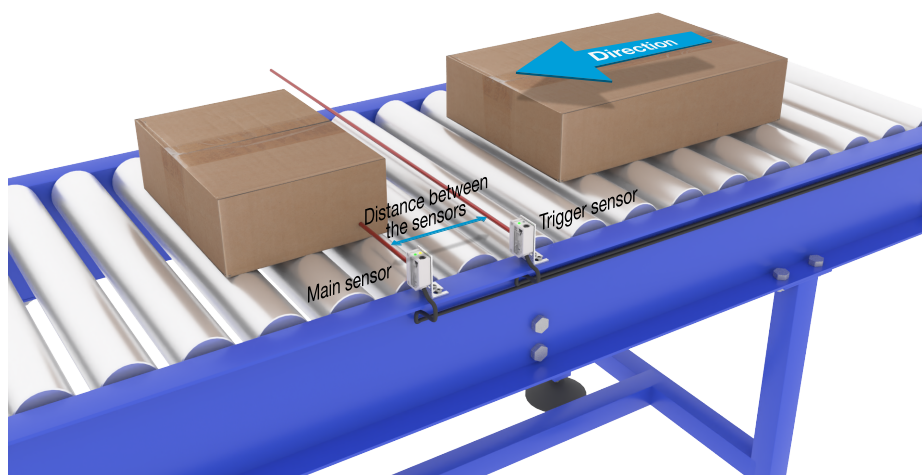

Alignment of Trigger and Main Sensor

Sensor preparation

- 1) Mount two sensors at the conveyor with an individual distance of e.g. 100 mm
- 2) Connect the two sensors to an SCTL55 or IO-Link master
- 3) Upload the IODD files in the SCTL55 or IO-Link Master
- 4) Switch on the power to the sensors
- 5) Restore the sensors to factory settings using the SCTL55 or IO-Link master.
- 6) Align the two sensors so the light beams are parallel to each other and aimed at the target.
- 7) Adjust the sensitivity on the sensors to get a reliable detection on the object.
(The yellow LED is ON, and the green LED is ON indicating stable ON and IO-Link Mode)

IO-Link parameter settings (see Data Range options in § 7.2.6.1.)

- 8) Trigger sensor: (The object passes the Trigger Sensor first)
 - a) Select "Speed and Length" in the SCTL55 or IO-Link master; Menu "Parameter" -> "Application Functions"
 - b) Select "Sensor role" -> "Trigger Sensor"
 - c) IO-Link Parameter Set-up is finished for the Trigger Sensor
- 9) Main sensor: (calculates Speed and Length and makes data available via IO-Link)
 - a) Reset the sensor using "Restore factory Settings"
(if already performed in point 5 then this can be skipped).
 - b) Select "Speed and Length" in the SCTL55 or IO-Link master; Menu "Parameter" -> "Application Functions"
 - c) Select "Sensor role" -> "Main Sensor".
 - d) Enter the distance in between the two sensors in [mm] in the menu "Speed and Length Measurement Main Sensor" -> "Distance between sensors"

- e) Select "Object Length" or "Object Speed" if required in "Process Data" in the "Observation menu" under "Process data configuration" -> "Analogue value"
 - i. Object Length will be shown in [mm]
 - ii. Object Speed will be shown in [mm/s]

10) Connect sensor output Pin 2 of the Trigger Sensor to Input Pin 2 of the Main Sensor

11) The Speed and length function is now ready for use.

NB! During the measurement variations in the conveyor speed may impact the result.

2.4.7.3. Pattern Recognition

The pattern recognition function is used to verify if a manufactured part has all the e.g. holes or taps as expected and that the parts are made according to the specification.

A pattern of a part can be recorded into the sensor and the following parts then compared to the pre-recorded pattern.

If pattern match, the sensor will respond with a positive signal or command either as standalone operation or via an IO-Link master

The pattern can max. contain 20 edges eg. 10 holes or 10 taps.

If multiple pattern are to be detected then several Main sensors can be connected to a single Trigger sensor.

2.4.7.3.1. Conditions

Two sensors are needed for this function a Trigger Sensor and a Main Sensor, however several Main sensors can be connected to the Trigger Sensor if more than one pattern must be examined simultaneously.

2.4.7.3.2. Pattern recognition – Setup procedure

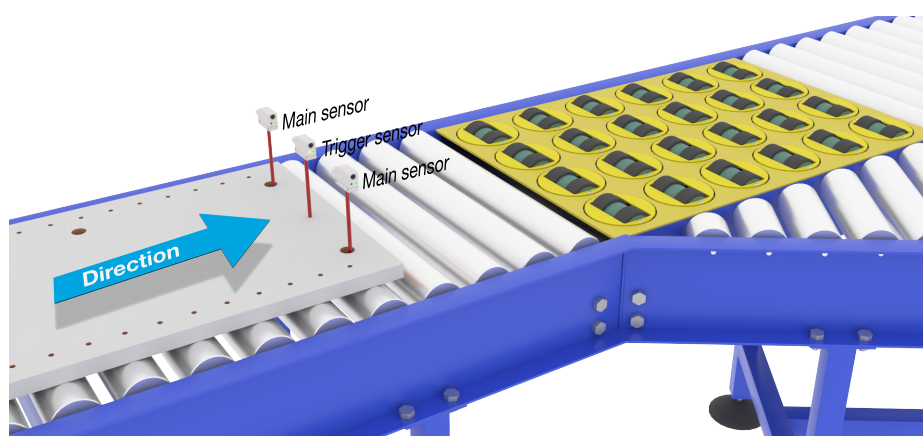

Alignment of Trigger and Main Sensor

Sensor preparation

- 1) Mount two sensors at the conveyor in line so the object will reach the two sensors at the same time.
- 2) Connect the two sensors to an SCTL55 or IO-Link master
- 3) Upload the IODD files in the SCTL55 or IO-Link Master
- 4) Switch on the power to the sensors
- 5) Restore the sensors to factory settings using the SCTL55 or IO-Link master.
- 6) Align the two sensors so the light beams will be detecting the edge of the target at the same time.
- 7) The trigger sensor must be mounted in a position where it will continuously detect the object without any holes or taps.
- 8) The Main sensor must be mounted so it detects the taps or holes that contain the pattern to be examined
- 9) Adjust the sensitivity on the sensors to get a reliable detection on the target.
(The yellow LED are ON, and the green LED are ON indicating Stable ON and IO-Link Mode)

IO-Link parameter settings (see Data Range options in § 7.2.6.2.)

- 10) Trigger sensor:
 - a) Select "Pattern Recognition" in the SCTL55 or IO-Link master; Menu "Parameter" -> "Application Functions"
 - b) Select "Sensor role" -> "Trigger Sensor"
 - c) IO-Link Parameter Set-up is finished for the Trigger Sensor
- 11) Main sensor:
 - a) Select "Pattern Recognition" in the SCTL55 or IO-Link master; Menu "Parameter" -> "Application Functions"
 - b) Select "Sensor role" -> "Main Sensor".
 - c) Enter the Timeout value used for maximum evaluation time between 1 ... 60 sec, in the menu "Pattern Recognition Setup" -> "Timeout" (default value is 60 sec.)
 - d) Enter the Tolerance of the Pattern in ‰ (Parts per thousand), between 1 and 200 ‰ in the menu "Pattern Recognition Setup" -> "Tolerance", default value is 50 ‰
- 12) Connect sensor output Pin 2 of the Trigger Sensor to Input Pin 2 of the Main Sensor(s)

Teach the Pattern

- 13) Activate the "Teach Pattern" command to start learning the pattern
- 14) Move the target at a steady speed passing fully by the two sensors
NB! During the measurement, variations in the conveyor speed may impact the result.
- 15) The sensor responds with:
 - a) "Saved" in "Pattern Recognition Result" -> "Reference Pattern"
 - b) "E.g. 12" in "Pattern Recognition Result" -> "Reference Pattern No Of Edges" (counts both the leading and trailing edges of the measurement targets).
 - c) Each edge is saved in ms from the leading edge of the complete measurement target and can be found in the Observation menu. When compared to the reference pattern the edges are normalized as a percentage value of the complete measurement target.
 This ensures that the pattern can be recognized at various constant speeds.
- 16) The Pattern can be saved as a project in the SCTL55 or IO-Link master and at a later point send back to the sensor in order to use this specific saved pattern as a reference pattern.
- 17) The Pattern Recognition function is now ready for use.
- 18) Move the target again at a steady speed passing fully by the two sensors
- 19) The Sensor responds with the text
 - a) "E.g. 12" in "Pattern Recognition Result" -> "Number of Edges Last Pattern"
- 20) "Patterns Match" in "Pattern Recognition Result" -> "Pattern Recognition Status"

Standalone operation in SIO Mode

- 21) Disconnect the sensor from the SCTL55 or IO-Link master and connect the Pin 4 to your e.g. decentral Tower light or good/bad conveyor belt
- 22) Once a valid pattern is detected the Pin 4 output responds with a 1 second pulse.

Multiple patterns

Multiple patterns can be detected simultaneously on the same target using only one Trigger sensor and multiple Main sensors, each Main sensor responds to a specific Pattern.

2.4.7.4. Divider function

This function allows e.g. the user to set up a number of counts to be performed before changing the output. By default, this value is set to 1 and each activation causes the output to change. When the value is set to a higher value e.g. 10 then the sensor will give output every 10th detection, the sensor will count at the trailing edge of the object. In the application example below the sensor shall change the output state after 8 products have been detected. The sensor output will indicate a "box full" and a new box is moved in front of the primary conveyor. The counter can be reset manually via the SO2, pre-configured as an external reset button.

2.4.7.4.1. Conditions

Only a single sensor is being used for this function.

2.4.7.4.2. Divider function – Setup procedure

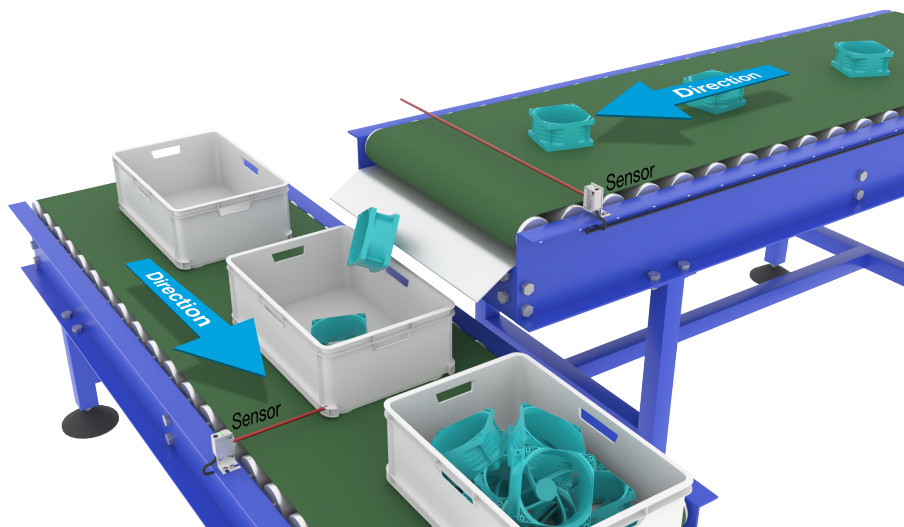

Alignment of Sensor

Sensor preparation

- 1) Mount the sensors at the conveyor at a position where the trailing edge of the target is detected just before it drops into the box.
- 2) Connect the sensor to an SCTL55 or IO-Link master.
- 3) Upload the IODD file in the SCTL55 or IO-Link Master.
- 4) Switch on the power to the sensor.
- 5) Restore the sensor to factory settings using the SCTL55 or IO-Link master.
- 6) Align the sensor so the light beam will detect the target.
- 7) Adjust the sensitivity on the sensor to get a reliable detection on the target.
(The yellow LED must light steady, and the green LED are ON indicating Stable ON and IO-Link Mode)

IO-Link parameter settings (see Data Range options in § 7.2.6.3.)

- 8) Select "Divider" in the SCTL55 or IO-Link master; Menu "Parameter" -> "Application Functions"
- 9) Enter the Counter value in the menu "Divider and Counter Setup" -> "Counter Limit" between 1 ... 65 535 (default value is 1)
- 10) If a preset value is needed this can be set in the menu "Divider and Counter" -> "Preset Counter value" between 0 ... 65 535 (default value is 0)

2.4.7.5. Object and Gap Monitoring

This function is designed to monitor that the length of an objects and the gap between the following object on a conveyor belt are within certain limits. The stand alone sensor gives a signal if the size of the object is too small, the objects overlap each other or if the gap between two objects are too small for the following processes.

2.4.7.5.1. Conditions

Only a single sensor is being used for this function.

2.4.7.5.2. Object and Gap Monitoring – Setup procedure

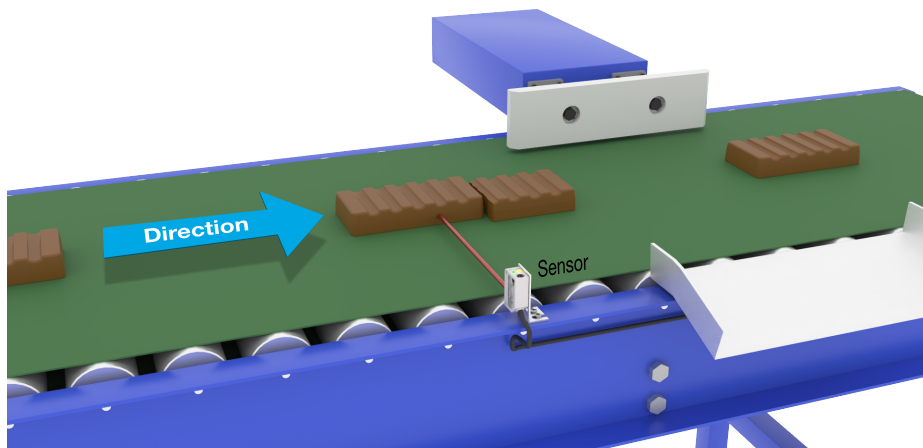

Alignment of Sensor

Sensor preparation

- 1) Mount the sensor at the conveyor at the required position.
- 2) Connect the sensor to an SCTL55 or IO-Link master.
- 3) Upload the IODD file in the SCTL55 or IO-Link Master.
- 4) Switch on the power to the sensor.
- 5) Restore the sensor to factory settings using the SCTL55 or IO-Link master.
- 6) Align the sensor so the light beam is aimed at the target to be detected.
- 7) Adjust the sensitivity on the sensor to get a reliable detection on the target.
(The yellow LED must light steady, and the green LED are ON indicating Stable ON and IO-Link Mode)

IO-Link parameter settings (see Data Range options in § 7.2.6.4)

- 8) Select "Object and Gap monitoring" in the SCTL55 or IO-Link master; Menu "Parameter" -> "Application Functions".
- 9) Object time:
 - a) Enter the minimum time the target will be present in the menu "Object and Gap monitor" -> "Object minimum time" between 10 ... 60 000 ms (default value is 500) ms, e.g. 130 ms.
As a help the Object time can be read from the "Object and Gap monitor" -> "Object time".
 - b) Enter the maximum time the target will be present in the menu "Object and Gap monitor" -> "Object maximum time" between 10 ... 60 000 ms (default value is 500) ms, e.g. 150 ms.
As a help the Object time can be read from the "Object and Gap monitor" -> "Object time".
- 10) Gap time:
 - a) Enter the minimum time the gap will be present in the menu "Object and Gap monitor" -> "Gap minimum time" between 10 ... 60 000 ms (default value is 500) ms, e.g. 110 ms.
As a help the gap time can be read from the "Object and Gap monitor" -> "Gap time".

b) Enter the maximum time the Gap will be present in the menu "Object and Gap monitor" -> "Gap maximum time" between 10 ... 60 000 ms (default value is 500) ms, e.g. 130 ms.

As a help the gap time can be read from the "Object and Gap monitor" -> "Gap time".

11) The sensor is now ready to use.

12) The Parameter for Object length will toggle between: Measurement running and Inside limits, Time too long or, Time too short.

13) The Parameter for Gap length will toggle between: Measurement running and Inside limits, Time too long or, Time too short.

Standalone operation in SIO Mode

14) Disconnect the sensor from the SCTL55 or IO-Link master.

15) Output Pin 4 will activate if the object time is too long or too short.

16) Output Pin 2 will activate if the gap time is too long or too short.

NB! If the signals of both outputs are evaluated using a logical OR function, the output of this OR function can be used as a common error output for both Object and Gap.

2.5. Sensor Specific adjustable parameters

Besides the parameters directly related to output configuration, the sensor also have various internal parameters useful for setup and diagnostics.

2.5.1. Selection of local or remote adjustment

It is possible to select how to set the sensing distance by either selecting the "Teach button" or "Teach-by-wire" using the external input of the sensor, or to disable the teach button by selecting "IO-Link Adjustment" to make the sensor tamperproof.

2.5.2. Teach-in range

Value between

- LD30CPBR10: 20 ... 125 mm
- LD30CPBR30: 20 ... 325 mm
- LD30CPBR60: 20 ... 625 mm

2.5.3. Process data configuration

When the sensor is operated in IO-Link mode, the user has access to the cyclic Process Data Variable.

By default the process data shows the following parameters as active: 16 bit Analogue value, Switching Output1 (SO1) and Switching Output 2 (SO2).

The following parameters are set as Inactive: SSC1, SSC2, DA1, DA2, TA, SC, AFO1.

However by changing the Process Data Configuration parameter, the user can decide to also enable the status of the inactive parameters. This way several states can be observed in the sensor at the same time.

NB! If Application functions are selected more options for "Analogue Values" can be selected in the Observation tab.

2.5.4. Sensor Measurement Selection

The sensor measurement selection is used for all the sensing presets below and valid for both SSC1 and SSC2.

Sensor presets:

0. Manual setup
1. Fine detection
2. Robust detection
3. Fast detection

Precision can be adjusted via parameter "Filter scaler". See 2.5.11.

Detection mode:

0. Fast mode
1. Precise mode

2.5.4.1. Fine detection

Used for applications that require detections close to a background, e.g. if the background is a conveying belt and the parts to detect are at the belt.

1. Hysteresis - Set automatically at minimum
2. Safe Margin - Set at 1% of the distance
3. Detection mode – Set to precise mode where more samples are used to get a better detection

2.5.4.2. Robust detection

In case the sensor is aligned with, the possibility to detect objects on two parallel conveying belts, then the BGS function ensure that the sensor will only detect objects on the conveying belt closest to the sensor while ignoring objects on the farthest conveying belt.

1. Hysteresis - Set automatically at standard (typically 3 times the minimum hysteresis)
2. Safe Margin - Set at 4% of the distance
3. Detection mode – Set to precise mode where more samples are used to get a better detection

2.5.4.3. Fast detection

Used for applications that require a fast detection speed with the background further away from the object to be detected. Reduced maximum sensing distance for black objects is to be expected.

1. Hysteresis - Set automatically at standard (typically 3 times the minimum hysteresis)
2. Safe Margin - Set at 4% of the distance
3. Detection mode – Set to fast mode for achieving minimum response time.

2.5.5. Temperature alarm threshold

The temperature at which the temperature alarm will activate can be changed for the maximum and minimum temperature. This means that the sensor will give an alarm if the maximum or minimum temperature is exceeded. The temperatures can be set between -50 °C to +150 °C. The default factory settings are, Low threshold -30 °C and high threshold +120 °C.

2.5.6. Safe limits

The Safe limits can be set for the sensor in % of the SP1 and SP2 and can be set individually for SSC1 and SSC2. It is used for calculating a Stable ON or Stable OFF signals.

- Dust alarm: If the Safe limits are exceeded then the dust alarm is activated, see also Dust alarm description
- The Green LED is also influenced by the Safe limits and can be used to set up the sensing distance manually adjusting until the LED lights Stable ON.

2.5.6.1. Stable ON

When the sensor detects a signal that are x % higher (set by Safe limits) than the value for which the output switches ON, then the sensor is stable ON.

2.5.6.2. Stable OFF

When the sensor detects a signal that are x % lower (set by Safe limits) than the value for which the outputs switches Off, then the sensor is stable OFF.

2.5.7. Event configuration

Temperature events transmitted over the IO-Link interface are turned off by default in the sensor. If the user wants to get information about critical temperatures detected in the sensor application, this parameter allows the following 4 events to be enabled or disabled:

- Temperature fault event: the sensor detects temperature outside the specified operating range.
- Temperature over-run: the sensor detects temperatures higher than those set in the Temperature Alarm threshold.
- Temperature under-run: the sensor detects temperatures lower than those set in the Temperature Alarm threshold.
- Short-circuit: the sensor detects if the sensor output is short-circuited.

2.5.8. Excess Gain

The Excess Gain value describe the ratio of the light received by the photoelectric sensor to the light required to operate the sensor.

The Excess gain value can be found in the Diagnostic tab of the SCTL55 or IO-Link master.

$$\text{Excess Gain} = \frac{\text{Light received by the sensor}}{\text{Light required to switch the output}}$$

2.5.9. Quality of run QoR

The Quality of run informs the user about the actual sensor performance, evaluating the following parameters: Maximum signal, Minimum signal, Hysteresis, SP and Safe Limits.

The value for QoR can vary from 0 ... 255 %.

The QoR value is updated for every detection cycle.

Examples of QoR is listed in the table below.

Quality of Run values	Explanation
> 150%	Excellent sensing conditions, the sensor is not expected to require maintenance in the near future.
100%	Good sensing conditions, the sensor performs as well as when the setpoints were taught or set-up manually with a safety margin of twice the standard hysteresis. <ul style="list-style-type: none"> • Long term reliability is expected under all environmental conditions. • Maintenance is not expected to be required.
50%	Average sensing conditions <ul style="list-style-type: none"> • Due to environmental conditions, the reliability of the measurement values is reduced and maintenance is required in order to improve the detection behavior. • If the environmental conditions remain stable, reliable detection can be expected for the near future.
0%	Unreliable sensing conditions, sensor does not work correctly, immediate maintenance required.

2.5.10. Quality of Teach QoT

The quality of Teach value lets the user know how well the actually the teach procedure was carried out, evaluating the relation between the following parameters: TP2, TP1, Hysteresis and Safe Limits.

The value for QoT can vary from 0 ... 255 %.

The QoT value is updated after every Teach procedure.

Examples of QoT are listed in the table below.

Quality of Teach values	Explanation
> 150%	Excellent teach conditions, the sensor is not expected to require maintenance in the near future.
100%	Good teach conditions, the sensor has been taught with the safe limits set at standard safe limits: <ul style="list-style-type: none"> • Long term reliability is expected under all environmental conditions. • Maintenance is not expected to be required.
50%	Average teach conditions. <ul style="list-style-type: none"> • The environmental conditions do not allow reliable detection for a longer period. Maintenance should be carried out in the near future. • If the environmental conditions remain stable, reliable detection can be expected for the near future.
0%	Poor teach result. <ul style="list-style-type: none"> • Poor sensing conditions for reliable detection. (e.g. too small measuring margin between the target and the surroundings).

2.5.11. Filter Scaler

This function can increase the immunity towards unstable targets and electromagnetic disturbances: Its value can be set from 1 to 255, the default factory setting is 1. The filter functions as a moving average. This means that a filter setting of 1 gives the maximum sensing frequency and a setting of 255 gives the minimum sensing frequency.

2.5.12. Mutual interference

In an optimal installation the sensors must be installed so they do not interfere with each other, however in some cases that is not possible, so the mutual interference protection function can be used. Using this function will increase the immunity significantly however it will also have a negative impact on the sensing speed. When the filter is activated, the sensor analyses the received signals and try to filter out interfering pulses.

1. sensor mode: is to be used where the sensor is disturbed by a foreign sensor, strong flashlight or a strong modulated light source e.g. LED lights.
The response time is increased 5 times
2. sensor mode: is to be used if two identical sensors are interfering each other.
The response time is increased 5 ... 6 times
3. sensor mode: is to be used if three identical sensors are interfering each other.
The response time is increased 5 ... 7 times

2.5.13. LED indication

The LED indication can be configured in 3 different modes: Inactive, Active or Find my sensor.

- **Inactive:** The LEDs are turned off at all times
- **Active:** The LEDs follow the indication scheme in 5.1.
- **Find my sensor:** The LEDs are flashing alternating with 2Hz with 50% duty cycle in order to easily locate the sensor.

2.5.14. Hysteresis mode

See 2.4.1.3.Hysteresis Settings

2.5.15. Auto hysteresis value

See 2.4.1.3.Hysteresis Settings

2.5.16. Cutoff distance

- LD30CPBR10: 20...150 mm
- LD30CPBR30: 20...350 mm
- LD30CPBR60: 20...650 mm

Measured distance beyond Cutoff distance, will be truncated to Cutoff distance.

Cutoff distance value will also be used when an object cannot be detected.

2.6. Teach procedure by use of SCTL55 or an IO-Link master

The setpoints can be set-up using a teach procedure, this ensures that the setpoints are set at an optimal value taking into consideration safe limits and hysteresis.

2.6.1. Dual Detection mode

Make sure that the sensor is in Dual Detection mode. This can be changed via an IO-Link master or our SCTL55 Smart Configurator in the Application Function menu.

Dual Detection, optimized switching point.

1. Aim the sensor at the background. The status of the Yellow LED and Green LED is not important.
2. Press the button for 3-6 seconds until both LEDs flash simultaneously one time per second, then release the button.
The Green and Yellow LED flash fast 4 times acknowledging that the background position and reflected intensity are recognized.

Teach distance and teach excess gain are automatically calculated and set to 100%, and the sensor is ready to operate (Green LED ON, Yellow LED OFF & SSC1 OFF).

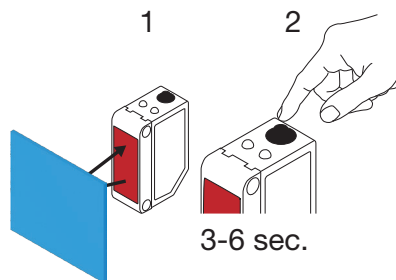

2.6.2. FGS mode

Make sure that the sensor is in FGS mode. This can be changed via an IO-Link master or our SCTL55 Smart Configurator.

FGS, optimized switching point.

1. Aim the sensor at the background. The status of the Yellow LED and Green LED is not important.
2. Press the button for 3-6 seconds until both LEDs flash simultaneously one time per second, then release the button.
The Green and Yellow LED flash simultaneously to indicate the sensor is ready to be taught the background.
3. Keep the sensor pointing at the background.
4. Press the button once (< 1 sec), the Yellow and Green LEDs flash fast 4 times acknowledging that the background is recognized.
SP1 and SP2 are automatically calculated and saved, and the sensor is ready to operate (Green LED ON, Yellow LED OFF).

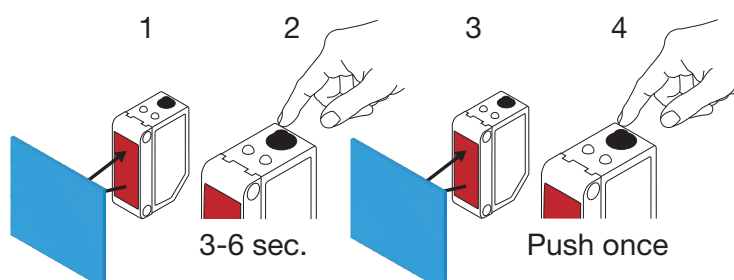

FGS, dynamic set-up (Optimizing variation of the Background)

1. Aim the sensor at the background. The status of the Yellow LED and Green LED is not important.
2. Press the button for 3-6 seconds until both LEDs flashes simultaneously one time per second, then release the button.
The Green and Yellow LED flash simultaneously to indicate the sensor is ready to be taught the background.
3. Keep the sensor pointing at the background.
4. Press and hold the button, while the Green and Yellow led flashes with 1 Hz, allowing the sensor to detect variations in the background until the button is released again, the Yellow and Green LEDs flash fast 4 times acknowledging that the background is recognized.
SP1 and SP2 are automatically calculated and saved, and the sensor is ready to operate (Green LED ON, Yellow LED OFF).

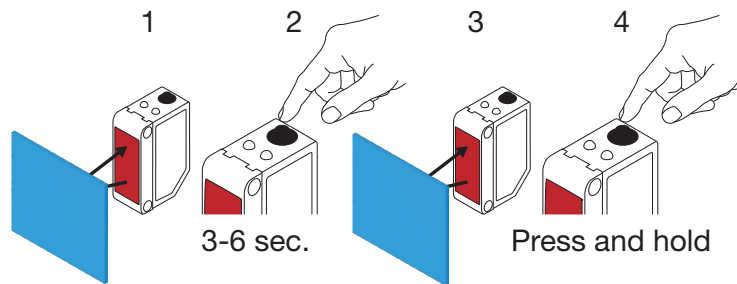

2.6.3. BGS mode

Make sure that the sensor is in Single Point mode (BGS). This can be changed via an IO-Link master or our SCTL55 Smart Configurator.

BGS, optimized switching point (3 – 6 sec.) Teaching both Background and Object

1. Aim the sensor at the background. The status of the Yellow LED and Green LED is not important.
2. Press the button for 3-6 seconds until both LEDs flashes simultaneously one time per second *, then release the button.
The Green and Yellow LEDs flash simultaneously 1 Hz to indicate the sensor has recognized the background.
3. Place the object in front of the sensor at the requested distance.
4. Press the button once (< 1 sec), the Yellow and Green LEDs flash fast 4 times indicating that the object is recognized.
SP1 is automatically calculated and saved, and the sensor is ready to operate (Green LED ON, Yellow LED ON, remove object and Yellow LED turns OFF).

The switching point is set between the background and the object.

* To Cancel the teach in progress, hold the button until the LEDs flashed 20 times.

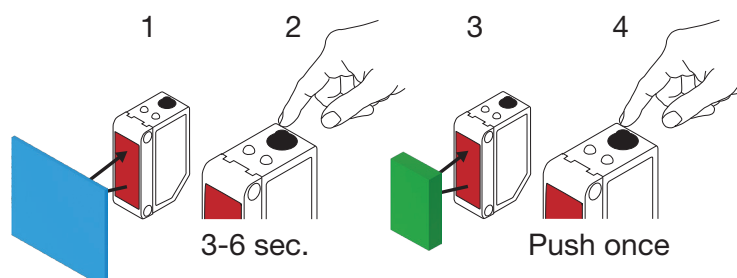

BGS, Background teach only (6 – 9 sec.)

1. Aim the sensor at the background. The status of the Yellow LED and Green LED is not important.
2. Press the button for 6-9 seconds until both LEDs flash simultaneously two times per second *, then release the button.

The Yellow and Green LEDs flash fast 4 times indicating that the background is recognized. SP1 is automatically calculated and saved, and the sensor is ready to operate (Green LED ON, Yellow LED OFF).

The switching point is set close to the Background.

* To Cancel the teach in progress, hold the button until the LEDs have flashed 20 times.

NB! For maximum background distance, teach without any Background in front of the sensor.

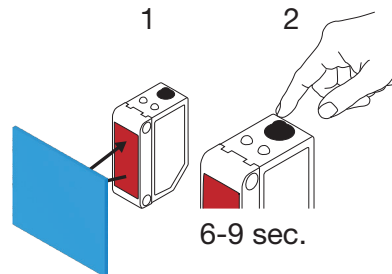

BGS, Object teach only (9 – 12 sec.)

1. Aim the sensor at the object. The status of the Yellow LED and Green LED is not important.
2. Press the button between 9 and 12 seconds until both LEDs flash simultaneously three time per second *, then release the button.

The Yellow and Green LED flash fast 4 times indicating that the background is recognized. SP1 is automatically calculated and saved, and the sensor is ready to operate (Green LED ON, Yellow LED OFF).

The switching point is set close to the object distance.

* To Cancel the teach in progress, hold the button until the LEDs flashed 20 times.

NB! For maximum distance, teach without any object in front of the sensor.

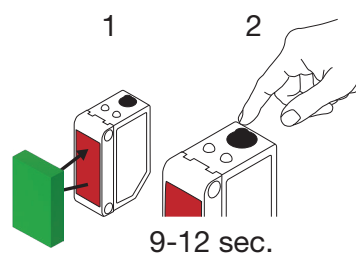

BGS, dynamic set-up (Optimizing variation of the Object and background)

1. Aim the sensor at the background. The status of the Yellow LED and Green LED is not important.
2. Press the button for 3-6 seconds until both LEDs flash simultaneously one time per second, then release the button.
The Green and Yellow LED flashes simultaneously to indicate the sensor has recognized the background.
3. Place the object between the background and the front of the sensor.
4. Press and hold the button, while the Green and Yellow led flashes with 1 Hz, allowing the sensor to detect variations in the object and the background until the button is released again. The Yellow and Green LEDs flash fast 4 times acknowledging that the variations are recognized.
SP1 is automatically calculated as a mean of the variations and saved. The sensor is now ready to operate (Green LED ON, Yellow LED ON, remove object and Yellow LED turns OFF).

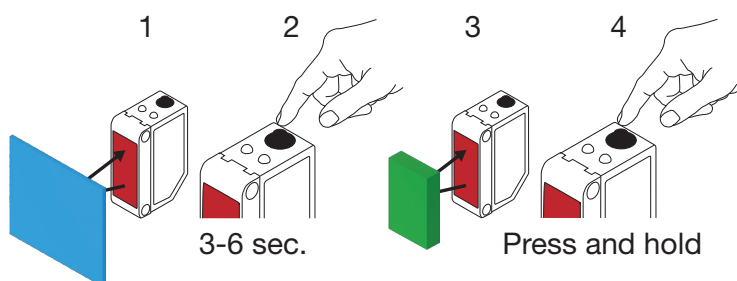

2.6.4. Teach from IO-Link Master or Smart configurator (SCTL55)

1. Select SSC1 or SSC2 configuration mode:
SSC1: Select: "Single point", "Window" or "Two Point" in "Switching signal channel1" -> "SSC1 Configuration.Mode".
NB! If "Single point" is selected, then "IO-Link adjustment" must be chosen in "SSC1 Single Point" -> "Selection of local/remote adjustment"
SSC2: Select: "Single point", "Window" or "Two Point" in "Switching signal channel2" -> "SSC2 Configuration.Mode".
2. Select channel to be taught e.g. "Switching signal channel 1" or "Switching signal channel 2" in "Teach-in" -> "Teach-in,Select".

2.6.4.1. Single point mode procedure

1) Single value teach command sequence:

Single value teach command sequence.

(Buttons are found in: "Teach-in SSC1" or "Teach-in SSC2" -> "Teach in single value SSC1" or "Teach-in single value SSC2").

1. Place the target in front of the sensor.
2. Press "Teach SP1".
3. Teach-in result is shown in "Teach-in Result. -> Teach-in State" e.g. "SUCCESS".
4. QoT is shown in "Quality of Teach" e.g. 100%.

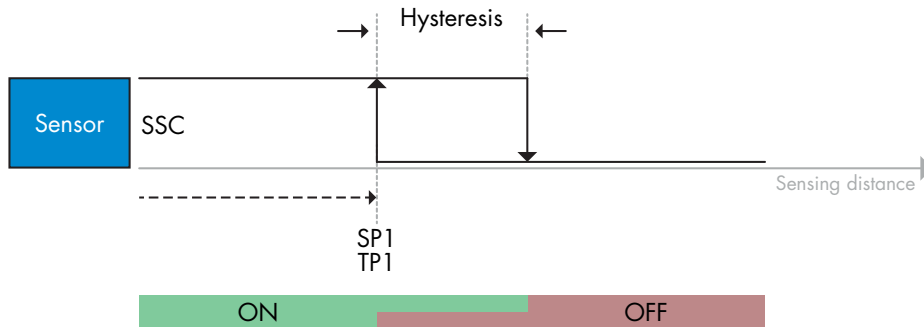

2) Dynamic teach command sequence

Dynamic teach for Single value teach command sequence

(Buttons are found in: "Teach-in SSC1" or "Teach-in SSC2" -> "Teach in dynamic SSC1" or "Teach-in dynamic SSC2")

1. Press "Teach SP1 Start".
2. Move the target in and out of the detecting zone, at slightly different positions, in front of the sensor.
3. Press "Teach SP1 Stop"
4. Teach-in result is shown in "Teach-in Result. -> Teach-in State" e.g. "SUCCESSSS"
5. QoT is shown in "Quality of Teach" e.g. 150 %

3) Two value teach command sequence

Two Value teach for SP1

(Buttons are found in: "Teach-in SSC1" or "Teach-in SSC2" -> "Teach-in Two value SSC1" or "Teach-in Two value SSC2")

1. Move the target to the position for SP1 TP1
 - A. Press "Teach SP1 TP1"
 - B. "Teach-in Result.TeachPoint 1 of Set Point 1" = e.g. "OK"
 - C. Teach-in Result.Teach-in state = e.g. "WAIT FOR COMMAND"
2. Move the target to the position for SP1 TP2
 - A. Press "Teach SP1 TP2".
 - B. Teach-in Result.TeachPoint 2 of Set Point 1" = e.g. "OK"
 - C. Teach-in Result. -> Teach-in State e.g. "SUCCESSSS"
3. QoT is shown in "Quality of Teach" e.g. 150 %

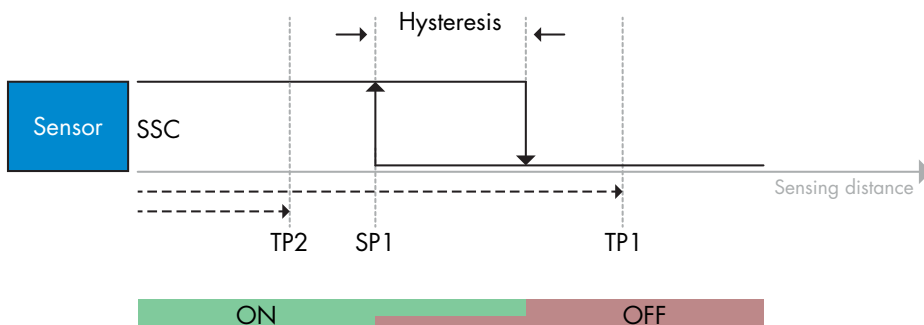

2.6.4.2. Two point mode procedure

1) Two value teach command sequence:

Buttons are found in menu: "Teach-in SSC1" or "Teach in SSC2" -> "Teach-in Two value SSC1" or "Teach-in Two value SSC2"

1. Move the target to the position for SP1 TP1
 - A. Press "Teach SP1 TP1"
 - B. "Teach-in Result.TeachPoint 1 of Set Point 1" = e.g. "OK"
 - C. Teach-in Result.Teach-in state = e.g. "WAIT FOR COMMAND"
2. Move the target to the position for SP1 TP2
 - A. Press "Teach SP1 TP2"
 - B. "Teach-in Result.TeachPoint 2 of Set Point 1" = e.g. "OK"
 - C. Teach-in Result.Teach-in state = e.g. "WAIT FOR COMMAND"
3. Move the target to the position for SP2 TP1
 - A. Press "Teach SP2 TP1"
 - B. "Teach-in Result.TeachPoint 1 of Set Point 2" = e.g. "OK"
 - C. Teach-in Result.Teach-in state = e.g. "WAIT FOR COMMAND"
4. Move the target to the position for SP2 TP2
 - A. Press "Teach SP2 TP2"
 - B. "Teach-in Result.TeachPoint 2 of Set Point 2" = e.g. "OK"
 - C. Teach-in Result.Teach-in state = e.g. "WAIT FOR COMMAND"
5. Press Teach Apply
 - A. Teach-in Result.Teach-in state = e.g. "Success"
6. QoT is shown in "Quality of Teach" e.g. 100 %

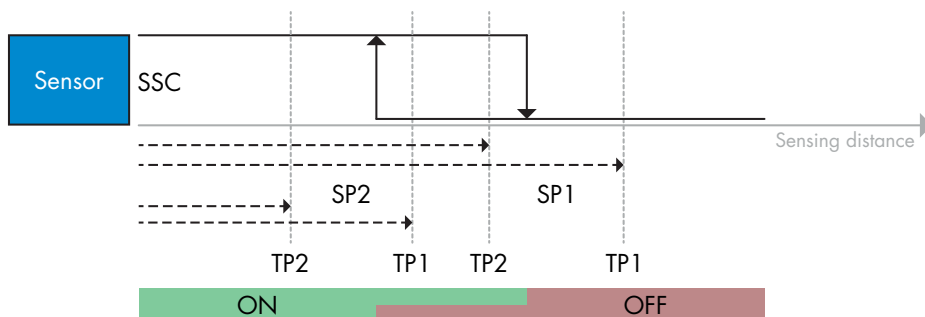

2) Dynamic teach command sequence:

Buttons are found in menu: "Teach-in Dynamic SSC1" or "Teach-in Dynamic SSC2" -> "Teach-in"

1. Move the target to the position for SP1
 - A. Press "Teach SP1 Start "
 - B. Teach-in Result.Teach-in state = e.g. "WAIT FOR COMMAND"
 - C. Press "Teach SP1 Stop "
 - D. Teach-in Result.Teach-in state = e.g. "WAIT FOR COMMAND"
2. Move the target to the position for SP2
 - A. Press "Teach SP2 Start "
 - B. Teach-in Result.Teach-in state = e.g. "WAIT FOR COMMAND"
 - C. Press "Teach SP2 Stop "
 - D. Teach-in Result.Teach-in state = e.g. "WAIT FOR COMMAND"
3. Teach-in Result.Teach-in state = e.g. "SUCCESS"
4. QoT is shown in "Quality of Teach" e.g. 100 %

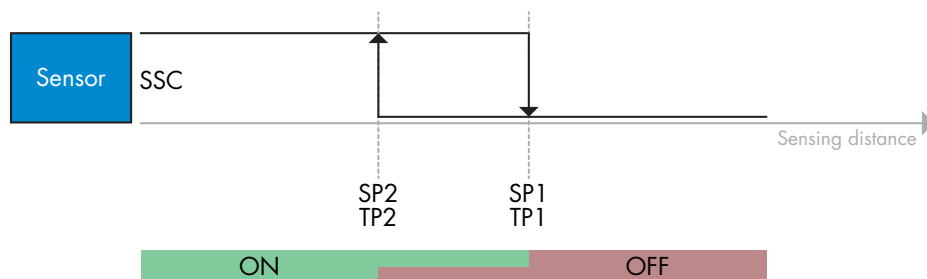

2.6.4.3. Windows mode procedure

1) Single value teach command sequence:

Buttons are found in menu: "Teach-in SSC1" or "Teach in SSC2" -> "Teach-in Single value SSC1" or "Teach-in Single value SSC2"

1. Move the target to the position for SP1
 - A. Press "Teach SP1"
 - B. Teach-in Result. Teach-in state = e.g. "WAIT FOR COMMAND"
2. Move the target to the position for SP2
 - A. Press "Teach SP2"
 - B. Teach-in Result. Teach-in state = e.g. "SUCCESS"
3. QoT is shown in "Quality of Teach" e.g. 255 %

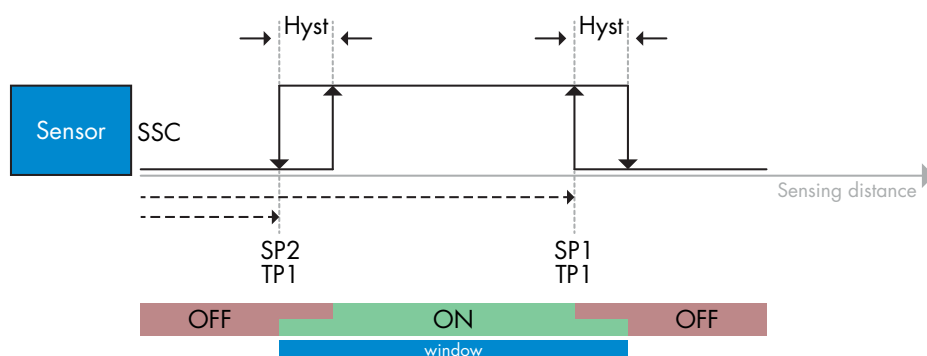

2) Dynamic teach command sequence:

Buttons are found in menu: "Teach-in SSC1" or "Teach-in SSC2" -> "Teach in Dynamic SSC1" or "Teach in Dynamic SSC2"

1. Move the target to the position for SP1
 - A. Press "Teach SP1 Start"
 - B. Teach-in Result. Teach-in state = e.g. "WAIT FOR COMMAND"
 - C. Press "Teach SP1 Stop"
 - D. Teach-in Result. Teach-in state = e.g. "WAIT FOR COMMAND"
2. Move the target to the position for SP2
 - A. Press "Teach SP2 Start"
 - B. Teach-in Result. Teach-in state = e.g. "WAIT FOR COMMAND"
 - C. Press "Teach SP2 Stop"
 - D. Teach-in Result. Teach-in state = e.g. "SUCCESS"
3. QoT is shown in "Quality of Teach" e.g. 100 %

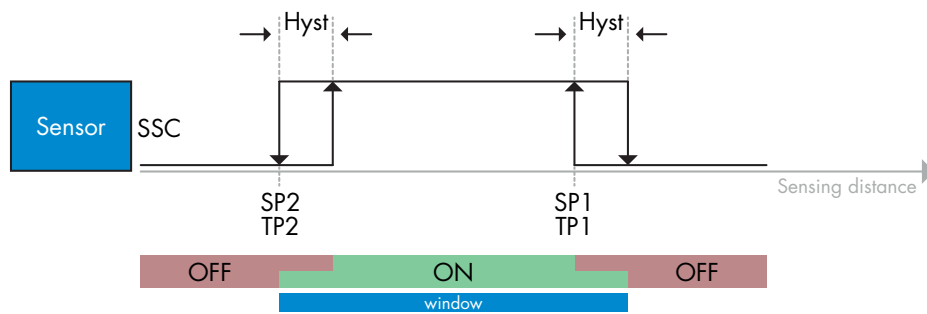

2.6.4.4. Foreground suppression mode

1) Single value teach command sequence:

The button is found in menu: "Teach-in SSC1" or "Teach-in SSC2" -> "Teach-in Single value SSC1" or "Teach-in Single value SSC2" -> "Teach Background"

1. Aim the sensor at the Background
 - A. Press "Teach Background"
 - B. Teach-in Result. Teach-in state = e.g. "SUCCESS"
2. QoT is shown in -> "Quality of Teach" e.g. 144 %

2) Dynamic teach command sequence:

The button is found in menu: "Teach-in SSC1" or "Teach-in SSC2" -> "Teach in Dynamic SSC1" or "Teach in Dynamic SSC2" -> "Teach Background"

1. Aim the sensor at the Background
 - A. Press "Teach Background start"
 - B. Teach-in Result. Teach-in state = e.g. "WAIT FOR COMMAND"
 - C. Press "Teach Background stop"
 - D. Teach-in Result. Teach-in state = e.g. "SUCCESS"
2. QoT is shown in -> "Quality of Teach" e.g. 100 %

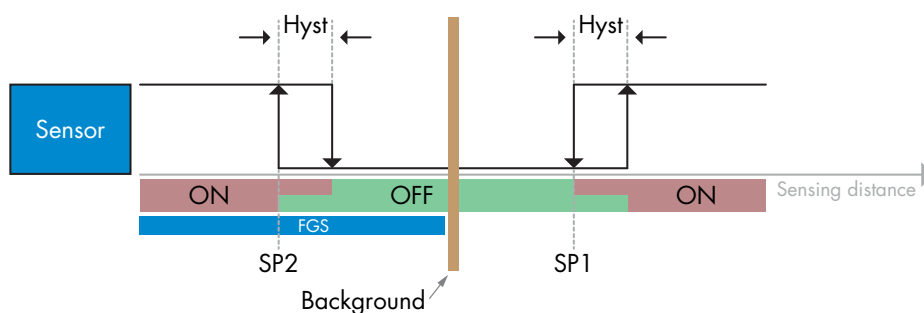

2.6.4.5. Dual Detection mode

Teach command sequence:

The button is found in menu "Dual Detection setup" -> "Teach Background".

1. Aim the sensor at the background.
 - a. Press "Teach Background".
 - b. Teach-in Result. Teach-in state = e.g. "SUCCESS".

2.7. Diagnostic parameters

2.7.1. Operating hours

The sensor has a built-in counter that logs every hour the sensor has been operational. The actual number of operating hours can be read through the SCTL55 or an IO-Link master.

2.7.2. Number of power cycles [cycles]

The sensor has a built-in counter that logs every time the sensor has been powered up. The value is saved every hour. The actual number of power cycles is recorded and can be read through the SCTL55 or an IO-Link master.

2.7.3. Maximum temperature – all time high [°C]

The sensor has a built-in function that logs the highest temperature the sensor has been exposed to during its full operational lifetime. This parameter is updated once per hour and can be read through the SCTL55 or an IO-Link master.

2.7.4. Minimum temperature – all time low [°C]

The sensor has a built-in function that logs the lowest temperature the sensor has been exposed to during its full operational lifetime. This parameter is updated once per hour and can be read through the SCTL55 or an IO-Link master.

2.7.5. Maximum temperature since last power-up [°C]

From this parameter the user can get information about what the maximum registered temperature has been since start-up. This value is not saved in the sensor, however it can be read through the SCTL55 or an IO-Link master.

2.7.6. Minimum temperature since last power-up [°C]

From this parameter the user can get information about what the minimum registered temperature has been since start-up. This value is not saved in the sensor, however it can be read through the SCTL55 or an IO-Link master.

2.7.7. Current temperature [°C]

From this parameter the user can get information about the current sensor temperature. The temperature can be read through the SCTL55 or an IO-Link master.

2.7.8. Detection counter [cycles]

The sensor logs every time the SSC1 changes state. This parameter is updated once per hour and can be read through the SCTL55 or an IO-Link master.

2.7.9. Minutes above maximum temperature [min]

The sensor logs how many minutes the sensor has been operational above the maximum temperature. The maximum number of minutes that can be recorded is 2 147 483 647. This parameter is updated once per hour and can be read through the SCTL55 or an IO-Link master.

2.7.10. Minutes below minimum temperature [min]

The sensor logs how many minutes the sensor has been operational below the minimum temperature. The maximum number of minutes that can be recorded is 2 147 483 647. This parameter is updated once per hour and can be read through the SCTL55 or an IO-Link master.

2.7.11. Download counter

The sensor logs how many times its parameters have been changed. The maximum number of changes that can be recorded is 65 536. This parameter is updated once per hour and can be read through the SCTL55 or an IO-Link master.

2.7.12. Dual Detection result

- 2.7.12.1 Distance match
- 2.7.12.2 Excess Gain match
- 2.7.12.3 Match
- 2.7.12.4 Background detected

NOTE!

The temperature measured by the sensor will always be higher than the ambient temperature, due to internal heating.

The difference between ambient temperature and internal temperature is influenced by how the sensor is installed in the application. If the sensor is installed in a metal bracket the difference will be lower than if the sensor is mounted in a plastic one.

3. Wiring diagrams

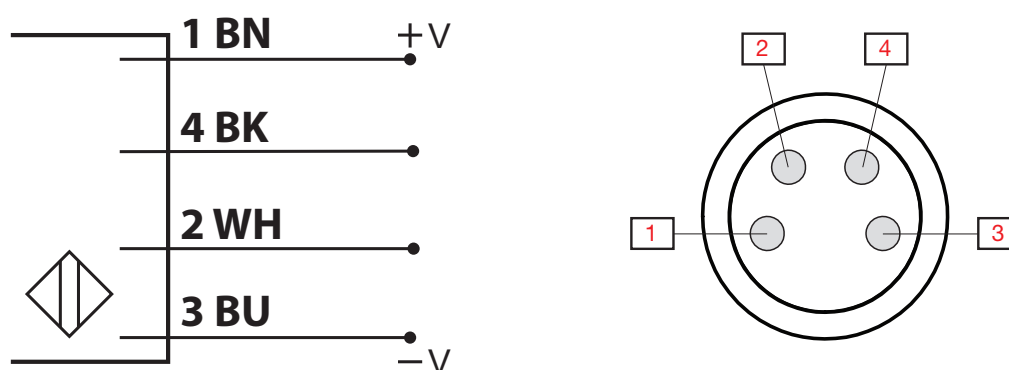

PIN	Color	Signal	Description
1	Brown	10 ... 30 VDC	Sensor Supply
2	White	Load	Output 2 / SIO mode / External input / External Teach
3	Blue	GND	Ground
4	Black	Load	IO-Link /Output 1 /SIO mode

4. Commissioning

150 ms after the power supply is switched on, the sensor will be operational.

If it is connected to an IO-link master, no additional setting is needed and the IO-Link communication will start automatically after the IO-Link master sends a wake-up request to the sensor.

5. Operation

5.1. User interface of LD30CPBRxxBPxxIO

LD30CPBRxxBPxxIO sensors are equipped with one yellow and one green LED.

SIO and IO-Link mode			
Green LED	Yellow LED	Power	Detection
● ON	● OFF	ON	OFF (stable) SSC1
● OFF	● OFF	ON	OFF (Not stable) SSC1 or LEDs disabled
● OFF	● ON	ON	ON (Not stable) SSC1
● ON	● ON	ON	ON (stable) SSC1
● OFF	● OFF	OFF	Power not connected
-	● Flashing 10 Hz 50% dutycycle	ON	Output short-circuit
-	● Flashing 0.5...20 Hz 50% dutycycle	ON	Timer triggered indication
IO-Link mode only			
● Flashing 1 Hz ON 900 ms OFF 100 ms	-	ON	Sensor is in IO-Link mode and SSC1 is stable
● Flashing 1 Hz ON 100 ms OFF 900 ms	-	ON	Sensor is in IO-Link mode and SSC1 is not stable
● ● Flashing 2 Hz 50% dutycycle		ON	Find my sensor

6. IODD file and factory setting

6.1. IODD file of an IO-Link device

All features, device parameters and setting values of the sensor are collected in a file called I/O Device Description (IODD file). The IODD file is needed in order to establish communication between the SCTL55 or the IO-Link master and the sensor. Every supplier of an IO-Link device has to supply this file and make it available for download on their web site.

The IODD file includes:

- process and diagnostic data
- parameters description with the name, the allowed range, type of data and address (index and sub-index)
- communication properties, including the minimum cycle time of the device
- device identity, article number, picture of the device and Logo of the manufacturer

An IODD file is available on IODD Finder as well as on the Carlo Gavazzi Website:

<http://gavazziautomation.com>

6.2. Factory settings

The Default factory settings are listed in appendix 7 under default values.

7. Appendix

7.1. Acronyms

IntegerT	Signed Integer
OctetStringT	Array of Octets
PDV	Process Data Variable
R/W	Read and Write
RO	Read Only
SO	Switching Output
SP	Set Point
TP	Teach Point
SSC	Switching Signal Channel
StringT	String of ASCII characters
TA	Temperature Alarm
UIntegerT	Unsigned Integer
WO	Write Only
SC	Short circuit
DA	Dust alarm
AFO1	Application Function Output 1
DD	Dual Detection

7.2. IO-Link Device Parameters for LD30CPBR IO-Link

7.2.1. Device Identification

Parameter Name	Index Dec (Hex)	Access	Default value	Data range	Data Type	Length
Vendor Name	16 (0x10)	RO	Carlo Gavazzi	-	StringT	20 Byte
Vendor Text	17 (0x11)	RO	www.gavazziautomation.com	-	StringT	34 Byte
Product Name	18 (0x12)	RO	(Sensor name) e.g. LD30CPBR60BPM510	-	StringT	20 Byte
Product ID	19 (0x13)	RO	(EAN code of product) e.g. 5709870406954	-	StringT	13 Byte
Product Text	20 (0x14)	RO	Photoelectric Laser Sensor	-	StringT	30 Byte
Serial Number	21 (0x15)	RO	(Unique serial number) e.g. LW01778070001	-	StringT	13 Byte
Hardware Revision	22 (0x16)	RO	e.g. V01.00	-	StringT	6 Byte
Firmware Revision	23 (0x17)	RO	e.g. V01.00	-	StringT	6 Byte
Application Specific Tag	24 (0x18)	R/W	***	Any string up to 32 characters	StringT	max 32 Byte
Function Tag	25 (0x19)	R/W	***	Any string up to 32 characters	StringT	max 32 Byte
Location Tag	26 (0x1A)	R/W	***	Any string up to 32 characters	StringT	max 32 Byte
Process-DataInput	40 (0x28)	RO	-	-	IntegerT	32 bit

7.2.2. Observation

Parameter Name	Index Dec (Hex)	Access	Default value	Data range	Data Type	Length
Process data configuration	70 (0x46)	R/W	-	-	-	-
Analogue value	1 (0x01)	R/W	1 = Normal	0 = Inactive 1 = Normal 2 = Object Length 3 = Object Speed 4 = Counter Value 5 = Dual Detection	RecordT	16 bit
Switching Output 1	2(0x02)	R/W	1 = Switching Output 1 Active	0 = Switching Output 1 Inactive 1 = Switching Output 1 Active	RecordT	16 bit
Switching Output 2	3 (0x03)	R/W	1 = Switching Output 2 Active	0 = Switching Output 2 Inactive 1 = Switching Output 2 Active	RecordT	16 bit
Switching Signal Channel 1	4 (0x04)	R/W	0 = SSC1 Inactive	0 = SSC1 Inactive 1 = SSC1 Active	RecordT	16 bit
Switching Signal Channel 2	5 (0x05)	R/W	0 = SSC2 Inactive	0 = SSC2 Inactive 1 = SSC2 Active	RecordT	16 bit
Dust alarm 1	6 (0x06)	R/W	0 = DA1 Inactive	0 = DA1 Inactive 1 = DA1 Active	RecordT	16 bit
Dust alarm 2	7 (0x07)	R/W	0 = DA2 Inactive	0 = DA2 Inactive 1 = DA2 Active	RecordT	16 bit
Temperature alarm	8 (0x08)	R/W	0 = TA Inactive	0 = TA Inactive 1 = TA Active	RecordT	16 bit
Short-circuit	9 (0x09)	R/W	0 = SC Inactive	0 = SC Inactive 1 = SC Active	RecordT	16 bit
Application Function Output 1	12 (0x12)	R/W	0 = AFO1 Inactive	0 = AFO1 Inactive 1 = AFO1 Active	RecordT	16 bit

7.2.3. SSC parameters

Parameter Name	Index Dec (Hex)	Access	Default value	Data range	Data Type	Length
Teach-In Select	58 (0x3A)	RW	1 = SSC1	0 = No Channel Selected 1 = SSC1 (Switching Signal Channel 1) 2 = SSC2 (Switching Signal Channel 2)	UIntegerT	8 bit
Teach-In Result	59 (0x3B)	-	-	-	-	-
Teach-in State	1 (0x01)	RO	0 = Idle	0 = Idle 1 = Success 4 = Wait for command 5 = Busy 7 = Error	RecordT	8 bit
TP1 (Teach Point 1) of SP1 (Set point 1)	2 (0x02)	RO	0 = Not OK	0 = Not OK 1 = OK	RecordT	8 bit
TP2 (Teach Point 2) of SP1 (Set point 1)	3 (0x03)	RO	0 = Not OK	0 = Not OK 1 = OK	RecordT	8 bit
TP1 (Teach Point 1) of SP2 (Set point 2)	4 (0x04)	RO	0 = Not OK	0 = Not OK 1 = OK	RecordT	8 bit
TP2 (Teach Point 2) of SP2 (Set point 2)	5 (0x05)	RO	0 = Not OK	0 = Not OK 1 = OK	RecordT	8 bit
SSC1 Parameter (Switching Signal Channel 1)	60 (0x3C)	-	-	-	-	-
Set point 1 (SP1)	1 (0x01)	R/W	100.0 mm for LD30CPBR10... 300.0 mm for LD30CPBR30... 600.0 mm for LD30CPBR60...	20.0 ... 125.0 mm for LD30CPBR10... 20.0 ... 325.0 mm for LD30CPBR30... 20.0 ... 625.0 mm for LD30CPBR60...	IntegerT	16 bit
Set point 2 (SP2)	2 (0x02)	R/W	20.0 mm..	20.0 ... 125.0 mm for LD30CPBR10... 20.0 ... 325.0 mm for LD30CPBR30... 20.0 ... 625.0 mm for LD30CPBR60...	IntegerT	16 bit
SSC1 Configuration (Switching Signal Channel 1)	61 (0x3D)	-	-	-	-	-
Switching Logic	1 (0x01)	R/W	0 = High active	0 = High active 1 = Low active	UIntegerT	8 bit
Mode	2 (0x02)	R/W	1 = Single Point	0 = Deactivated 1 = Single Point 2 = Window 3 = Two Point 4 = FGS	UIntegerT	8 bit
Hysteresis* (manual)	3 (0x03)	R/W	7 mm for LD30CPBR10... 20 mm for LD30CPBR30... 40 mm for LD30CPBR60...	1.0 ... 125.0 mm for LD30CPBR10... 1.0 ... 325.0 mm for LD30CPBR30... 1.0 ... 625.0 mm for LD30CPBR60...	UIntegerT	16 bit
SSC2 Parameter (Switching Signal Channel 2)	62 (0x3E)	-	-	-	-	-
Set point 1 (SP1)	1 (0x01)	R/W	100.0 mm for LD30CPBR10... 300.0 mm for LD30CPBR30... 600.0 mm for LD30CPBR60...	20.0 ... 125.0 mm for LD30CPBR10... 20.0 ... 325.0 mm for LD30CPBR30... 20.0 ... 625.0 mm for LD30CPBR60...	IntegerT	16 bit
Set point 2 (SP2)	2 (0x02)	R/W	20.0 mm	20.0 ... 125.0 mm for LD30CPBR10... 20.0 ... 325.0 mm for LD30CPBR30... 20.0 ... 625.0 mm for LD30CPBR60...	IntegerT	16 bit
SSC2 Configuration (Switching Signal Channel 2)	63 (0x3F)	-	-	-	-	-
Switching Logic	1 (0x01)	R/W	0 = High active	0 = High active 1 = Low active	UIntegerT	8 bit
Mode	2 (0x02)	R/W	0 = Deactivated	0 = Deactivated 1 = Single Point 2 = Window 3 = Two Point 4 = FGS	UIntegerT	8 bit
Hysteresis (manual)	3 (0x03)	R/W	7.0 mm for LD30CPBR10... 20.0 mm for LD30CPBR30... 40.0 mm for LD30CPBR60...	1.0 ... 125.0 mm for LD30CPBR10... 1.0 ... 325.0 mm for LD30CPBR30... 1.0 ... 625.0 mm for LD30CPBR60...	UIntegerT	16 bit

* Please notice that SCC1 default use automatic hysteresis. See index 80 and 81

7.2.4. Output Parameters

Parameter Name	Index Dec (Hex)	Access	Default value	Data range	Data Type	Length
Channel 1 Setup (S01)	64 (0x40)	-	-	-	-	-
Stage Mode	1 (0x01)	R/W	1 = PNP output	0 = Disabled output 1 = PNP output 2 = NPN output 3 = Push-pull output	UIntegerT	8 bit
Input selector 1	2 (0x02)	R/W	1 = SSC 1	0 = Deactivated 1 = SSC 1 2 = SSC 2 3 = Dust Alarm 1 (DA1) 4 = Dust alarm 2 (DA2) 5 = Temperature Alarm (TA) 6 = External logic input 7 = Application Functions	UIntegerT	8 bit
Timer Mode	3 (0x03)	R/W	0 = Disabled timer	0 = Disabled timer 1 = T-on delay 2 = T-off delay 3 = T-on/T-off delay 4 = One-shot leading edge 5 = One-shot trailing edge	UIntegerT	8 bit
Timer Scale	4 (0x04)	R/W	0 = Milliseconds	0 = Milliseconds 1 = Seconds 2 = Minutes	UIntegerT	8 bit
Timer Value	5 (0x05)	R/W	0	0 ... 32 767	IntegerT	16 bit
Logic function	7 (0x07)	R/W	0 = Direct	0 = Direct 1 = AND 2 = OR 3 = XOR 4 = Set-reset Flip-Flop	UIntegerT	8 bit
Output Inverter	8 (0x08)	R/W	0 = Not inverted (Normally Open)	0 = Not inverted (Normally Open) 1 = Inverted (Normally Closed)	UIntegerT	8 bit
Channel 2 Setup (S02)	65 (0x41)	-	-	-	-	-
Stage Mode	1 (0x01)	R/W	1 = PNP output	0 = Disabled output 1 = PNP output 2 = NPN output 3 = Push-Pull 4 = Digital logic input (Active high/ Pull-down) 5 = Digital logic input (Active low/ Pull-up) 6 = Teach-in (Active high)	UIntegerT	8 bit
Input selector 2	2 (0x02)	R/W	1 = SSC 1	0 = Deactivated 1 = SSC 1 2 = SSC 2 3 = Dust Alarm 1 (DA1) 4 = Dust alarm 2 (DA2) 5 = Temperature Alarm (TA) 6 = External logic input 7 = Application Functions	UIntegerT	8 bit
Timer Mode	3 (0x03)	R/W	0 = Disabled timer	0 = Disabled timer 1 = T-on delay 2 = T-off delay 3 = T-on/T-off delay 4 = One-shot leading edge 5 = One-shot trailing edge	UIntegerT	8 bit
Timer Scale	4 (0x04)	R/W	0 = Milliseconds	0 = Milliseconds 1 = Seconds 2 = Minutes	UIntegerT	8 bit
Timer Value	5 (0x05)	R/W	0	0 ... 32 767	IntegerT	16 bit
Logic function	7 (0x07)	R/W	0 = Direct	0 = Direct 1 = AND 2 = OR 3 = XOR 4 = Set-reset Flip-Flop	UIntegerT	8 bit
Output Inverter	8 (0x08)	R/W	1 = Inverted (Normally Closed)	0 = Not inverted (Normally Open) 1 = Inverted (Normally Closed)	UIntegerT	8 bit

7.2.5. Sensor specific adjustable parameters

Parameter Name	Index Dec (Hex)	Access	Default value	Data range	Data Type	Length
Selection of local/remote adjustment	68 (0x44)	R/W	3 = Teach-by-button	0 = IO-Link adjust 2 = Teach-by-wire 3 = Teach-by-button	UIntegerT	8 bit
Sensor preset	71 (0x47)	R/W	1 = Fine detection	0 = Manual setup 1 = Fine detection 2 = Robust detection 3 = Fast detection	UIntegerT	8 bit
Filter scaler	77 (0x4D)	R/W	1	1 ... 255	UIntegerT	8 bit
CutOff distance	79 (0x4F)	R/W	150.0 mm for LD30CPBR10... 350.0 mm for LD30CPBR30... 670.0 mm for LD30CPBR60...	20.0 ... 150.0 mm for LD30CPBR10... 20.0 ... 350.0 mm for LD30CPBR30... 20.0 ... 670.0 mm for LD30CPBR60...	UIntegerT	16 bit
Precision mode	100 (0x64)	R/W	1 = Precise	0 = Fast 1 = Precise	UInteger	8 bit
Temperature Alarm Threshold	72 (0x48)	-	-	-	-	-
High Threshold	1 (0x01)	R/W	60°C	-30 ... 70°C	IntegerT	16 bit
Low Threshold	2 (0x02)	R/W	-20°C	-30 ... 70°C	IntegerT	16 bit
Safe limits	73 (0x49)	-	-	-	-	-
SSC 1 - Safe limit	1 (0x01)	R/W	1%	1 ... 100%	IntegerT	8 bit
SSC 2 - Safe limit	2 (0x02)	R/W	1%	1 ... 100%	IntegerT	8 bit
LED indication	78 (0x4E)	R/W	1 = LED indication Active	0 = LED indication Inactive 1 = LED indication Active 2 = Find my sensor	UIntegerT	8 bit
Hysteresis Mode	80 (0x50)	R/W	2 = Automatic hysteresis (Fine)	0 = Manual Hysteresis* 1 = Automatic hysteresis (Robust) 2 = Automatic hysteresis (Fine)	UIntegerT	8 bit
SSC1 Auto hysteresis value	81 (0x51)	-	-	-	-	-
Auto Hysteresis Value SP1**	1 (0x01)	RO	-	1.0 ... 125.0 mm for LD30CPBR10... 1.0 ... 325.0 mm for LD30CPBR30... 1.0 ... 625.0 mm for LD30CPBR60...	UIntegerT	16 bit
Auto Hysteresis Value SP2**	2 (0x02)	RO	-	1.0 ... 125.0 mm for LD30CPBR10... 1.0 ... 325.0 mm for LD30CPBR30... 1.0 ... 625.0 mm for LD30CPBR60...	UIntegerT	16 bit
Minimum Excess Gain Level	82 (0x52)	-	-	-	-	-
Minimum Excess Gain Level	1 (0x01)	R/W	1.00	1.00 ... 1 000.00	UIntegerT	32 bit
Dust response time	2 (0x02)	R/W	2 sec	1 ... 255 sec	UIntegerT	8 bit
Dust reset time	3 (0x03)	R/W	2 sec	1 ... 255 sec	UIntegerT	8 bit
Mutual interference protection	84 (0x54)	R/W	0 = Off	0 = Off 1 = 1sensor mode 2 = 2sensor - sensor1 3 = 2sensor - sensor2 4 = 3sensor - sensor1 5 = 3sensor - sensor2 6 = 3sensor - sensor3	UInteger	8 bit

* For manual hysteresis. See index 61.3

** Automatic hysteresis is calculated based on SP, whenever SP's are changed

7.2.6. Application Function

Parameter Name	Index Dec (Hex)	Access	Default value	Data range	Data Type	Length
Application Function Selector	88 (0x58)	RO	0 = No application function selected	0 = No application function selected 1 = Speed and Length 2 = Pattern Recognition 3 = Divider 4 = Object and Gap Monitoring 5 = Dual Detection	UIntegerT	8 bit

7.2.6.1. Dual Detection

Parameter Name	Index Dec (Hex)	Access	Default value	Data range	Data Type	Length
Dual Detection setup	98 (0x62)					
Teach distance	1 (1x01)	RW	100.0 mm for LD30CPBR10 300.0 mm for LD30CPBR30 600.0 mm for LD30CPBR60	20...125.0 mm for LD30CPBR10 20...325.0 mm for LD30CPBR30 20...625.0 mm for LD30CPBR60	UIntegerT	32 bit
Teach excess gain	2 (1x02)	RW	2000	0...65535	UIntegerT	33 bit
Setpoint	3 (1x03)	RW	75	0...100	UIntegerT	8 bit
Hysteresis	4 (1x04)	RW	10	0...100	UIntegerT	8 bit
Auto level	5 (1x05)	RW	1 - Enabled	0 - Disabled 1 - Enabled	UIntegerT	8 bit

7.2.6.2. Speed and Length

Parameter Name	Index Dec (Hex)	Access	Default value	Data range	Data Type	Length
Setup	89 (0x59)	-	-	-	-	-
SensorMode	1 (0x01)	R/W	0 = No Role selected	0 = No Role selected 1 = Trigger Sensor 2 = Main Sensor	UIntegerT	8 bit
Distance between sensors	2 (0x02)	R/W	100 mm	25 ... 150 mm	UIntegerT	8 bit
Results	90 (0x5A)	-	-	-	-	-
Object Speed	1 (0x01)	RO	-	0 ... 2 000 mm/sec	UIntegerT	16 bit
Object length	2 (0x02)	RO	-	25 ... 60 000 mm	UIntegerT	16 bit
Status	3 (0x03)	RO	0 = IDLE	0 = IDLE 1 = Measurement Running 2 = Speed too High 3 = Timeout 4 = Object too Long 5 = Logic Fail	UIntegerT	8 bit

7.2.6.3. Pattern Recognition

Parameter Name	Index Dec (Hex)	Access	Default value	Data range	Data Type	Length
Pattern Recognition Setup	91 (0x5B)	-	-	-	-	-
TimeOut	1 (0x01)	R/W	60 sec	1 ... 60 sec	UIntegerT	8 bit
Tolerance	2 (0x02)	R/W	50 %	1 ... 200 %	UIntegerT	8 bit
Sensor Role	3 (0x03)	R/W	0 = No role selected	0 = No role selected 1 = Trigger Sensor 2 = Main Sensor	UIntegerT	8 bit
Pattern Recognition Result	92 (0x5C)	-	-	-	-	-
Reference pattern	1 (0x01)	RO	0 = Not Saved	0 = Not Saved 1 = Saved	UIntegerT	8 bit
Reference pattern No of Edges	2 (0x02)	RO	0	0 ... 20	UIntegerT	8 bit
No of Edges Last Pattern	3 (0x03)	RO	0	0 ... 20	UIntegerT	8 bit
Pattern Recognition Status	4 (0x04)	RO	0 = IDLE	0 = IDLE 1 = Measurement running 2 = Pattern Match 3 = Timeout 4 = Too many Edges 5 = EDGE count ERROR 6 = EDGE timing ERROR	UIntegerT	8 bit
Observation Menu						
Pattern recognition	97 (0x61)	-	-	-	-	-
Timestamp 1 ... 20	1 ... 20 (0x01 ... 14)	R/W	0	Time stamp for each event [ms]. Relative to start (time 0)	UIntegerT	16 bit
Pattern Timestamp 1 ... 20	21 ... 40 (0x15 ... 28)	R/W	0 = No Edge	0 = No Edge 1 = Positive Edge 2 = Negative Edge	UIntegerT	8 bit
Object Time Length	41 (0x29)	R/W	0 ms	0 ... 65 535 ms	UIntegerT	16 bit
Reference pattern	42 (0x2A)	R/W	0 = Not Saved	0 = Not Saved 1 = Saved	UIntegerT	8 bit
Reference pattern No of Edges	43 (0x2B)	R/W	0	0 ... 20	UIntegerT	8 bit

7.2.6.4. Divider

Parameter Name	Index Dec (Hex)	Access	Default value	Data range	Data Type	Length
Divider and counter Setup	93 (0x5D)	-	-	-	-	-
Counter limit	1 (0x01)	R/W	5	1 ... 65 535	UIntegerT	16 bit
Preset counter value	2 (0x02)	R/W	0	0 ... 65 535	UIntegerT	16 bit
Result	94 (0x5E)	-	-	-	-	-
Counter value	1 (0x01)	RO	-	0 ... 65 535	UIntegerT	16 bit

7.2.6.5. Object and Gap Monitoring

Parameter Name	Index Dec (Hex)	Access	Default value	Data range	Data Type	Length
Object and Gap Monitoring Setup	95 (0x5F)	-	-	-	-	-
Object minimum time	1 (0x01)	R/W	500 ms	10 ... 60 000 ms	UIntegerT	16 bit
Object maximum time	2 (0x02)	R/W	10 000 ms	10 ... 60 000 ms	UIntegerT	16 bit
Gap minimum time	3 (0x03)	R/W	500 ms	10 ... 60 000 ms	UIntegerT	16 bit
Gap maximum time	4 (0x04)	R/W	10 000 ms	10 ... 60 000 ms	UIntegerT	16 bit
Object and Gap Monitoring Result	96 (0x60)	-	-	-	-	-
Object time	1 (0x01)	RO	0 ms	0 ... 60 000 ms	UIntegerT	16 bit
Gap time	2 (0x02)	RO	0 ms	0 ... 60 000 ms	UIntegerT	16 bit
Object status	3 (0x03)	RO	0 = Idle	0 = Idle 1 = Measurement running 2 = Inside limits 3 = Time too long 4 = Time too short	UIntegerT	8 bit
Gap status	4 (0x04)	RO	0 = Idle	0 = Idle 1 = Measurement running 2 = Inside limits 3 = Time too long 4 = Time too short	UIntegerT	8 bit

7.2.7. Diagnostic parameters

Parameter Name	Index Dec (Hex)	Access	Default value	Data range	Data Type	Length
Sensor Diagnostics						
Frontend Failure	209 (0xD1)	RO	0 = OK	0 = OK. 1 = Fail.	IntegerT	8 bit
EE_MemoryFailure (during power up)	208 (0xD0)	-	-	-	-	-
Memory Failure	1 (0x01)	RO	0 = OK	0 = OK. 1 = Fail.	IntegerT	8 bit
Temperature Diagnostics						
Maximum temperature – All time high	203 (0xCB)	RO	- °C	-50 ... 150 [°C]	IntegerT	16 bit
Minimum temperature - All time low	204 (0xCC)	RO	- °C	-50 ... 150 [°C]	IntegerT	16 bit
Maximum temperature since power-up	205 (0xCD)	RO	- °C	-50 ... 150 [°C]	IntegerT	16 bit
Minimum temperature since power-up	206 (0xCE)	RO	- °C	-50 ... 150 [°C]	IntegerT	16 bit
Current temperature	207 (0xCF)	RO	- °C	-50 ... 150 [°C]	IntegerT	16 bit
Minutes above Maximum Temperature	211 (0xD3)	RO	0 min	0 ... 2 147 483 647 [min]	IntegerT	32 bit
Minutes below Minimum Temperature	212 (0xD4)	RO	0 min	0 ... 2 147 483 647 [min]	IntegerT	32 bit
Operating Diagnostics						
Operating Hours	201 (0xC9)	RO	0 h	0 ... 2 147 483 647 [h]	IntegerT	32 bit
Number of Power Cycles	202 (0xCA)	RO	0	0 ... 2 147 483 647	IntegerT	32 bit
Detection counter SSC1	210 (0xD2)	RO	0	0 ... 2 147 483 647	IntegerT	32 bit
Maintenance event counter	213 (0xD5)	RO	0	0 ... 2 147 483 647	IntegerT	32 bit
Download counter	214 (0xD6)	RO	0	0 ... 65 536	UIntegerT	16 bit
Quality of Teach	75 (0x4B)	RO	-	0 ... 255	UIntegerT	8 bit
Quality of Run	76 (0x4C)	RO	-	0 ... 255	UIntegerT	8 bit
Excess Gain	83 (0x53)	RO	-	1 ... 255%	UIntegerT	8 bit
Error Count	32 (0x20)	RO	0	0 ... 65 535	UIntegerT	16 Bit
Device Status	36 (0x24)	RO	0 = Device is operating properly	0 = Device is operating properly 1 = Maintenance required 2 = Out-of-specification 3 = Functional-Check 4 = Failure	UIntegerT	8 Bit
Dual Detection	99 (0x63)	-	-	-	-	-
Distance match %	1(0x01)	rRO	-	0 ... 100%		
Excess gain match %	2(0x02)	RO	-	0 ... 100%		
Match %	3(0x03)	RO	-	0 ... 100%		
Background detected	4(0x04)	RO	0 = Background not detected	0 = Background not detected 1 = Background detected		
Detailed Device Status	37 (0x25)	-	-	-	-	-
Temperature fault	-	RO	-	-	OctetStringT	3 Byte
Temperature over-run	-	RO	-	-	OctetStringT	3 Byte
Temperature under-run	-	RO	-	-	OctetStringT	3 Byte
Short-circuit	-	RO	-	-	OctetStringT	3 Byte
Maintenance Required	-	RO	-	-	OctetStringT	3 Byte

7.2.7. Diagnostic parameters (cont.)

Parameter Name	Index Dec (Hex)	Access	Default value	Data range	Data Type	Length
Event Configuration						
Event Configuration	74 (0x4A)	-	-	-	-	-
Maintenance event (0x8C30)	1 (0x01)	R/W	0 = Maintenance event Inactive	0 = Maintenance event Inactive 1 = Maintenance event Active	RecordT	16 bit
Temperature fault event (0x4000)	2 (0x02)	R/W	0 = Temperature fault event Inactive	0 = Temperature fault event Inactive 1 = Temperature fault event Active	RecordT	16 bit
Temperature over-run event (0x4210)	3 (0x03)	R/W	0 = Temperature over-run event Inactive	0 = Temperature over-run event Inactive 1 = Temperature over-run event Active	RecordT	16 bit
Temperature under-run event (0x4220)	4 (0x04)	R/W	0 = Temperature under-run event Inactive	0 = Temperature under-run event Inactive 1 = Temperature under-run event Active	RecordT	16 bit
Short circuit event (0x7710)	5 (0x05)	R/W	0 = Short circuit event Inactive	0 = Short circuit event Inactive 1 = Short circuit event Active	RecordT	16 bit

Dimensions

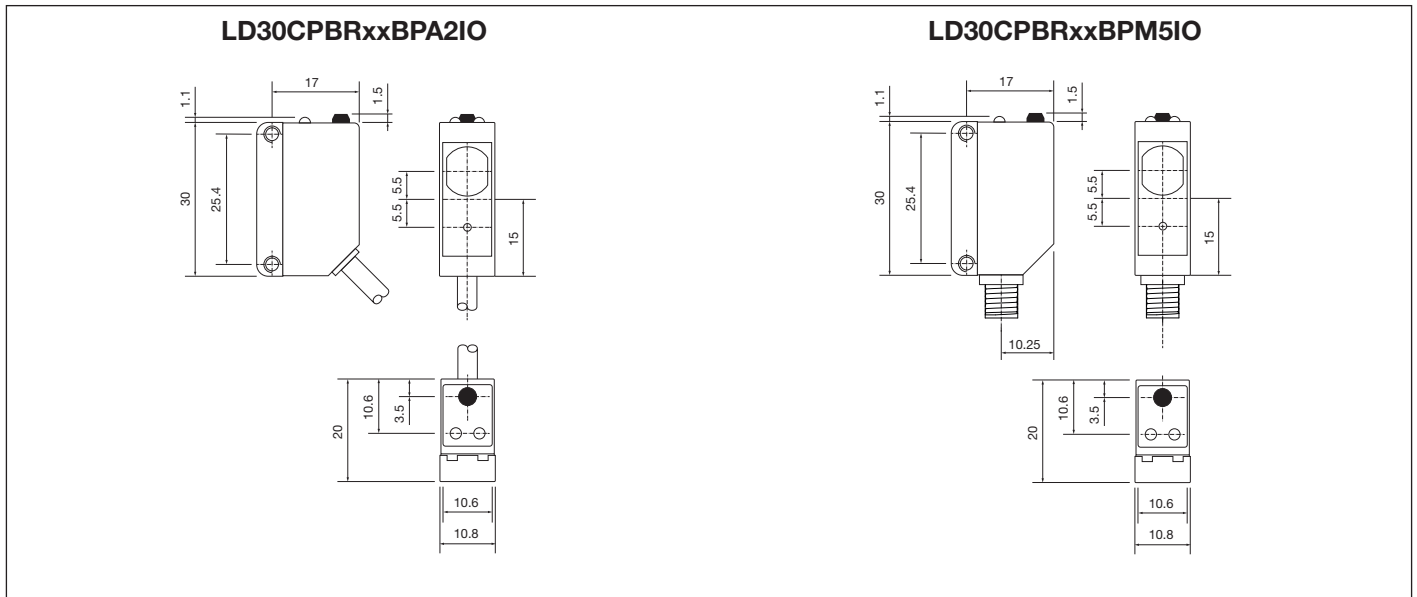

Installation Hints

<i>To avoid interference from inductive voltage/ current peaks, separate the prox. switch power cables from any other power cables, e.g. motor, contactor or solenoid cables</i>	<i>Relief of cable strain</i> The cable should not be pulled	<i>Protection of the sensing face</i> A proximity switch should not serve as mechanical stop	<i>Switch mounted on mobile carrier</i> Any repetitive flexing of the cable should be avoided

LD30CPBR10-IO Fast mode

White background 90% (inches)

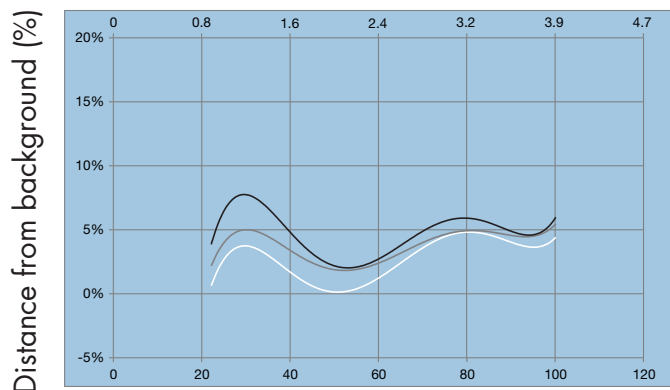
**LD30CPBR10-IO Precise mode**

White background 90% (inches)

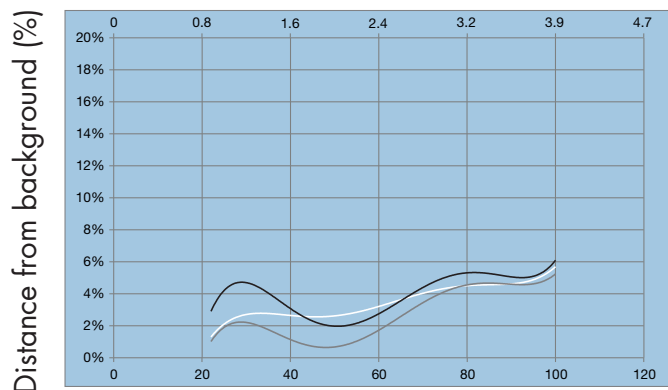

White background 90% (mm)

LD30CPBR30IO Fast mode

White background 90% (inches)

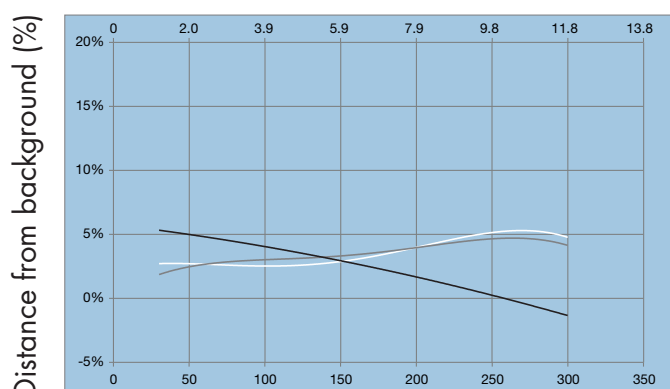

White background 90% (mm)

LD30CPBR30IO Precise mode

White background 90% (inches)

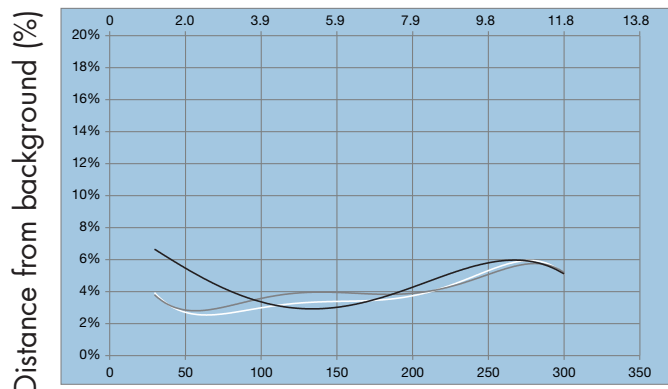

White background 90% (mm)

White background 90% (mm)

LD30CPBR60-IO Fast mode

White background 90% (inches)

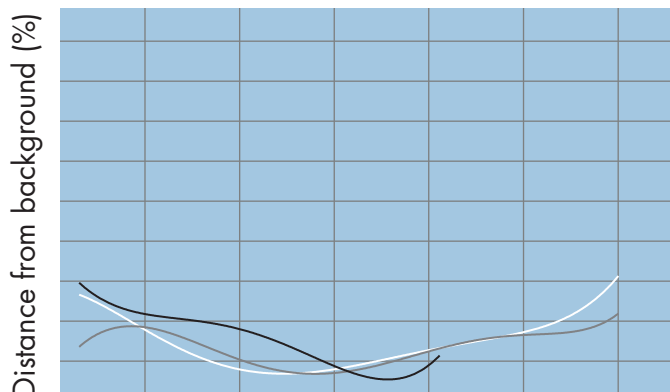

White background 90% (mm)

LD30CPBR60-IO precise mode

White background 90% (inches)

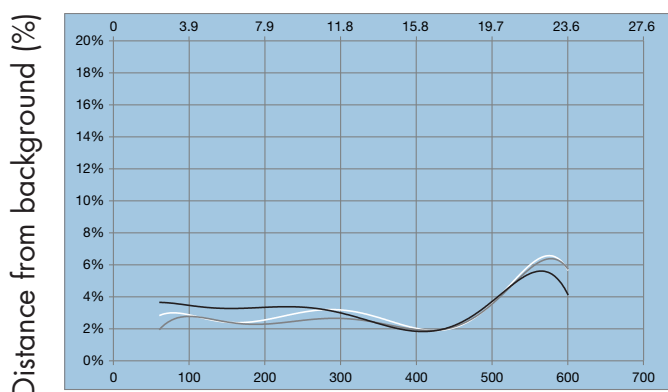

White background 90% (mm)

(White on white 90%/90%)

(Grey on white 18%/90%)

(Black on white 6%/90%)

Detection diagram

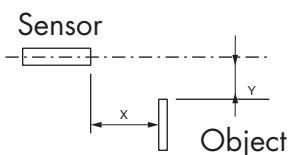
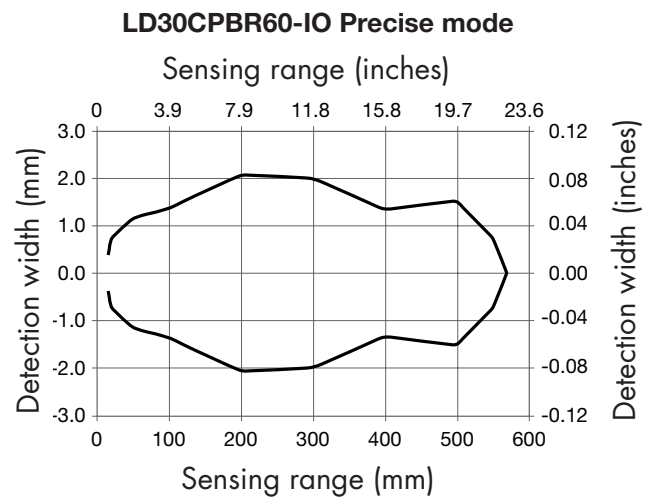
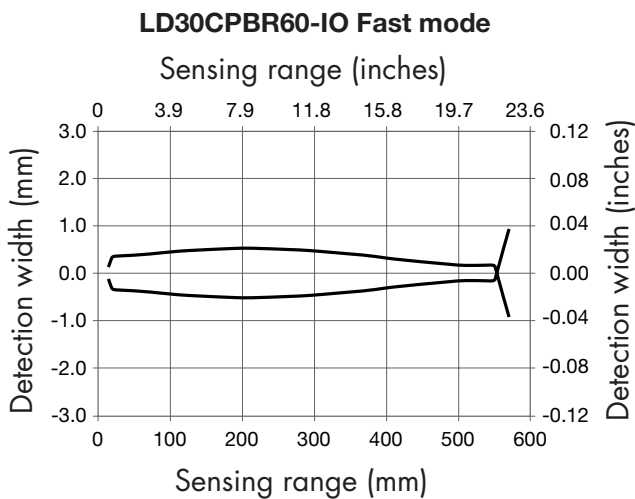
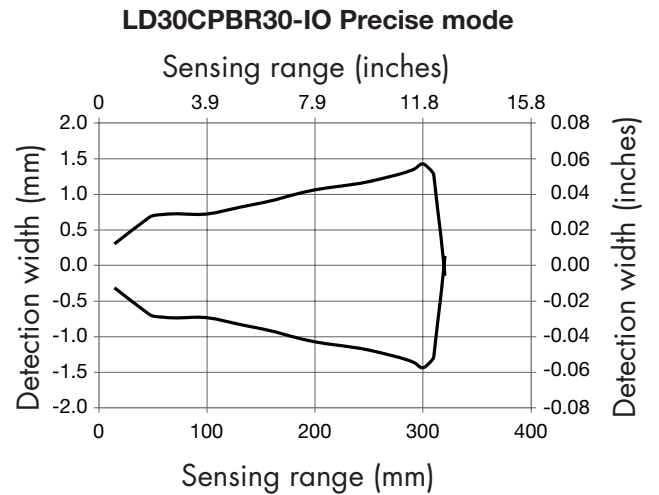
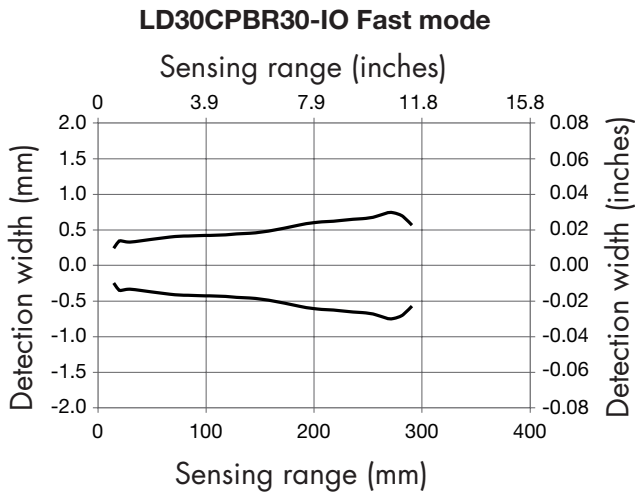
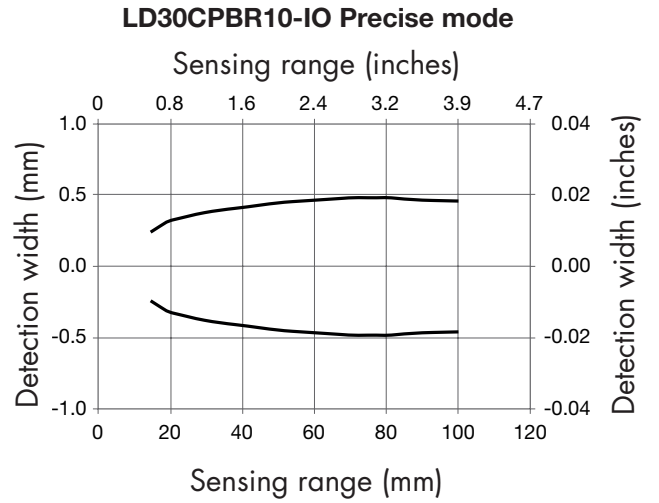
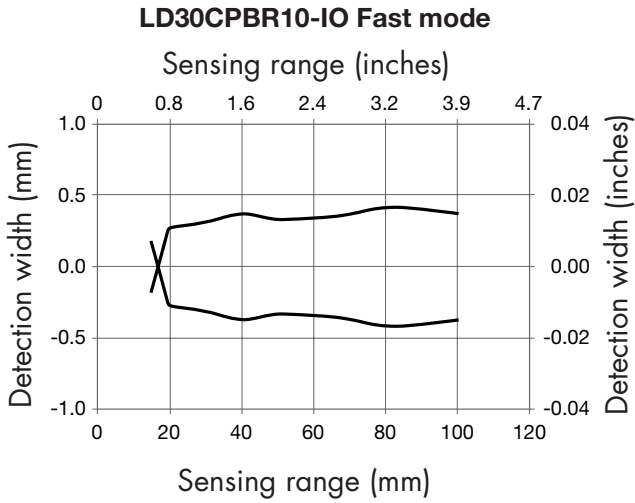

CARLO GAVAZZI
www.gavazziautomation.com



Certified in accordance with ISO 9001